



**NURE**

Kharkiv National University of Radio  
Electronics

Міністерство  
освіти і науки  
України



Ukraine  
Ministry of Education



**ESKIŞEHİR TEKNİK ÜNİVERSİTESİ**  
ESKIŞEHİR TECHNICAL UNIVERSITY

# ICONAT 2019

**KHARKIV-UKRAINE**  
**SEPTEMBER 18-20, 2019**

**INTERNATIONAL CONFERENCE**

**ON**

**NATURAL SCIENCE AND TECHNOLOGY**

## CONFERENCE PROGRAMME

[www.iconat-2019.com](http://www.iconat-2019.com)





**CHAIRMAN OF CONFERENCE**

**Prof. Dr. Semenets Valerii, Rector, NURE, (Ukraine)**

**ORGANIZING COMMITTEE**

Prof. Dr. Omarov Murad, Vice-Rector, NURE, (Ukraine)

Vice-Chairman (ICONAT 2019)

Prof. Dr. Mykhailo Neofitny, Vice-Rector, NURE, (Ukraine)

Assoc. Prof. Dr. Abidin Kılıç, Eskisehir Technical University, Turkey

Prof. Dr. Hakan Dal, Eskisehir Technical University, Turkey

Prof. Dr. Oleksandr Filipenko, NURE, (Ukraine)

Prof. Dr. Andriy Yerokhin, NURE, (Ukraine)

Assoc. Prof. Dr. Oleksii Liashenko, NURE, (Ukraine)

**International Scientific Committee**

Prof. Dr. Andrii Chukhrai (Ukraine)

Prof. Dr. Arturas Mickus (Lithuania)

Prof. Dr. Cengiz Türe (Turkey)

Prof. Dr. Dmytro Fedasyuk (Ukraine)

Prof. Dr. Ekrem Gürel (Turkey)

Assoc. Prof. Dr. Feridun Ay (Turkey)

Assoc. Prof. Dr. Haluk Yapıcıoğlu (Turkey)

Prof. Dr. Hüseyin Sarı (Turkey)

Prof. Dr. Igor Ruzhentsev (Ukraine)

Prof. Dr. Igor Nevlidov (Ukraine)

Prof. Dr. İsmail Sökmen (Turkey)

Prof. Dr. Kadir Aslan (USA)

Prof. Dr. Marzena S. Miichalowska (Poland)

Prof. Dr. Murat Tanışlı (Turkey)

Prof. Dr. Mustafa Hoştut (Turkey)

Prof. Dr. Mustafa Şenyel (Turkey)

Prof. Dr. Oleh Avrunin (Ukraine)

Prof. Dr. Oleg Lazarenko (Ukraine)

Prof. Dr. Oleksandr Lemeshko (Ukraine)

Prof. Dr. Oleksandr Tsopa (Ukraine)

Prof. Dr. Orhan Görgülü (Turkey)

Prof. Dr. Saliha İlcan (Turkey)

Prof. Dr. Sevil Çetinkaya Gürer (Turkey)

Prof. Dr. Süleyman Demir (Turkey)

Prof. Dr. Svetlana Kashuba (Poland)

Prof. Dr. Valentin Filatov (Ukraine)

Prof. Dr. Volodymyr Storozhenko (Ukraine)

Prof. Dr. Yevgenii Bodyansky (Ukraine)

Prof. Dr. Yevgen Nelin (Ukraine)

Prof. Dr. Yuri Machekhin (Ukraine)

Prof. Dr. Yüksel Ergün (Turkey)

Prof. Dr. Zafer Demir (Turkey)



**ICONAT 2019**

**Official Opening of the ICONAT-2019**

**18 September 2019**

**Meeting Saloon – NURE**

- 09.00      The Start of Registration Process
- 10.30      Official Opening of the ICONAT-2019  
Welcome by Conference
- Prof. Dr. Semenets Valerii, Chairman (ICONAT 2019)  
Rector, NURE, (Ukraine)
- Representative of Kharkiv Regional State Administration
- Prof. Dr. Omarov Murad, Vice-Chairman (ICONAT 2019)  
Vice-Rector, NURE, (Ukraine)
- Assoc. Prof. Dr. Abidin Kılıç, ESTU  
Member of ICONAT 2019 Organization Committee
- Representative of Lifecell “ICONAT 2019 Conference Sponsor “
- 11.00      Keynote Lecture  
Prof. Dr. Yüksel Ergün  
Eskisehir Technical University Turkey
- 11.30      Keynote Lecture  
Prof. Dr. Murat Tanisli  
Eskisehir Technical University Turkey
- 12.00      Lunch Break
- 13.00      Keynote Lecture  
Prof. Dr. Igor Grebennik  
Kharkiv National University of Radio Electronics - Ukraine
- 13.30      Keynote Lecture  
Prof. Dr. Ramesh Kumar  
Guru Kashi University - India



18.09.2019 Wednesday

ORAL PRESENTATIONS	
<b>Chairing</b> <b>Prof. Dr. Saliha Ilican</b>	<b>Hall 1</b> <b>14.00</b>
Sevil Cetinkaya Turkey	Green Reduction of Graphene Oxide by Using Kombucha Tea
Ruken Esra Demirdogen Turkey	Supramoleculartheranostic Platforms Goes Green
Mohammad AL RAWAJBEH Jordan	Adoption of Cloud Computing in Higher Education Sector: An Overview
<b>Break 14.45-15.00</b>	

ORAL PRESENTATIONS	
<b>Chairing</b> <b>Prof. Dr. Dursun Aydın</b>	<b>Hall 2</b> <b>14.00</b>
Ömer Aydın Turkey	Smart Grid Integreted With Hybrid Renewable Energy Systems
Sergey Lutskyy Ukraine	The Information on Results of The Physical Size Measurement
Murat Tanışlı Turkey	Investigation of Argon Plasma Jets with Spectral Line Intensity Ratio
<b>Break 14.45-15.00</b>	



**18.09.2019 Wednesday**

<b>ORAL PRESENTATIONS</b>	
<b>Chairing</b> <b>Assoc. Prof. Dr. Roman Orel</b>	<b>Hall 1</b> <b>15.00</b>
Duygu Anaklı Turkey	The Effect of the Three Types of Surfactants in the Structure and Properties of Organo-Modified Bentonite Clay
Olga Isaeva Ukraine	Development of An Automated System For Video Dermatoscopy
Anastasiia Kovalova Ukraine	Microcirculation Evaluation Capabilities Using Capillaroscopy
<b>Break 15.45-16.00</b>	

<b>ORAL PRESENTATIONS</b>	
<b>Chairing</b> <b>Prof. Dr. Nihal Kuş</b>	<b>Hall 2</b> <b>15.00</b>
Saliha Ilican Turkey	Structural Analysis and Photophysical Properties of Proline
Neslihan Şahin Turkey	Characterization of Neon Plasma Jets Generated by Dielectric Barrier Discharge-Like System at Atmospheric Pressure
Walide Nacerim Algeria	Modeling of Experimental Data for Biomedical Laboratory
<b>Break 15.45-16.00</b>	

**18.09.2019 Wednesday**

<b>ORAL PRESENTATIONS</b>	
<b>Chairing</b> <b>Assoc. Prof. Dr. Mykola</b> <b>Moskalets</b>	<b>Hall 1</b> <b>16.00</b>
Roman Orel Ukraine	Detection of "Wall Thinning" Type Defects in Pipelines by Thermal Method
Sevil Cetinkaya  Turkey	Effect of the Synthesis Temperature of Polycarboxylate-based Superplasticizers on the Performance of Concrete
Len Si Hian China	Application of Machine Learning Systems to bioinformatics Resources
<b>Break 16.45-17.00</b>	

<b>ORAL PRESENTATIONS</b>	
<b>Chairing</b> <b>Prof. Dr. Zafer Demir</b>	<b>Hall 2</b> <b>16.00</b>
Nihal Kus Turkey	Photo-Isomerization Reactions of Oxygen Containing Molecules using Matrix Isolation Spectroscopy
Nihal Kus Turkey	Theoretical and Experimental Infrared Spectrum Analysis of Cationic 1-Ethyl-3-Methylimidazolium Ionic Liquid
Şadiye Çakmak  Turkey	Effect of Deformation, Particle-Hole And Particle-Particle Interaction on Gamow-Teller Transitions Of <sup>76</sup> Ge
<b>Break 16.45-17.00</b>	

**18.09.2019 Wednesday**

<b>ORAL PRESENTATIONS</b>	
<b>Chairing</b> Assoc. Prof. Dr. Mohammad <b>AL RAWAJBEH</b>	<b>Hall 1</b> <b>17.00</b>
Ali Jabbar Al-Lemane Lebanon	The relationship between headache types and blood groups and socioeconomic factors
Ruken Esra Demirdogen Turkey	Synthesis of Corchoruscapsularis Fibers Modified with Layered Double Hydroxides and Their Use in Cleaning Waters from Oils
Alexei Trubitsyn Ukraine	Use of nonlinear optimization algorithm and discrete Fourier transforms to control dermatoscopic examinations

<b>ORAL PRESENTATIONS</b>	
<b>Chairing</b> <b>Prof. Dr. Meryem Akbelen</b>	<b>Hall 2</b> <b>17.00</b>
Sedef Dikmen Turkey	Mechanical Activation of Fly Ash: Physical, Mineralogical and Morphological Characterization of Ground Fly Ashes
Utku Kaya Turkey	Brinell Indentation Diameter Measurement without Using An Optical Microscope
Saliha Ilıcan Turkey	Fabrication and I-V Characteristics of p-Si/n-ZnO:Er Heterojunctions



ICONAT 2019

19.09.2019 Thursday

ORAL PRESENTATIONS	
<b>Chairing</b> <b>Assoc. Prof. Dr. Abidin Kilic</b>	<b>Hall 1</b> <b>10.00</b>
Duygu Anaklı Turkey	Optimal Temperature Control in a Batch Polymerization Reactor Using Deadbeat Control
Alexei Trubitsyn Ukraine	Comparison of segmentation algorithms in the processing of dermatoscopic images of patients with atopic dermatitis
Iryna Suchyk Ukraine	Indicators of Spermatogenesis in the Lake Frog ( <i>Rana Rıdibunda</i> Pall.) in the Zone of the Influence of Burshtyn Thermal Power Plant
<b>Break 10.45-11.00</b>	

ORAL PRESENTATIONS	
<b>Chairing</b> <b>Prof. Dr. Sevil Cetinkaya</b>	<b>Hall 2</b> <b>10.00</b>
Sadiye Cakmak Turkey	The Study of Classics Particles' Energy at Archimedean Solids with Clifford Algebra
Meryem Akbelen Turkey	Investigation of thermal and structural properties of nitric, hydrochloric and sulphuric acid-treated zeolite
Dursun Aydın Turkey	Semiparametric regression estimates based on some transformation techniques for right-censored data
<b>Break 10.45-11.00</b>	



19.09.2019 Thursday

ORAL PRESENTATIONS	
<b>Chairing</b> <b>Dr. Sergey Lutsky</b>	<b>Hall 1</b> <b>11.00</b>
Abidin Kilic Turkey	Structure of Vortex of Condensed Gas in Trapped Cloud
Andriy A. Onishchenko Ukraine	Dynamical Fractal Analysis of the Acoustic Ultra-Wideband Signal Caused by the Chelyabinsk Meteoroid
Tsekhmistro Roman Ukraine	Use of automatic microprocessors technology control in the systems of OVOJECTORS in their adaptation to the conditions of the former CIS.
<b>Break 11.45-12.00</b>	

ORAL PRESENTATIONS	
<b>Chairing</b> <b>Assoc. Prof. Dr. Sedef Dikmen</b>	<b>Hall 2</b> <b>11.00</b>
Polonska Y. Ukraine	Adsorption Capacity on Toxic Metals Ions of the Silica Gel Surface, In Situ Modified by poly[8-methacroyloxy quinoline]
Mykola Moskalets Ukraine	Analysis of Restrictions Influence in Implementation of Space-Time Access Methods
Hvostyk IHOR Ukraine	Optimization of Transport Mobile Communication Network
<b>Break 11.45-12.00</b>	

**LUNCH BREAK**



## 19.09.2019 Thursday

ORAL PRESENTATIONS	
<b>Chairing</b> <b>Dr. Sadiye Cakmak</b>	<b>Hall 1</b> <b>14.00</b>
Derya Kilic Turkey	Synthesis of <i>Luffa cylindrica</i> Fibers Modified with Layered Double Hydroxides
Meryem Akbelen Turkey	Hydrogen Adsorption Capacities of Natural and Salt Treated Zeolite
Oleksandr LEMESHKO Ukraine	Method Of Congestion Management And Balanced Resource Allocation On Mpls-Te Telecommunication Network Routers
<b>Break 14.45-15.00</b>	

ORAL PRESENTATIONS	
<b>Chairing</b> <b>Dr. Sadiye Cakmak</b>	<b>Hall 2</b> <b>14.00</b>
Yusif Gasimov Azerbaijan	Information and communication technologies in informatization of the Republic of Azerbaijan's Economy
Kozar A.I Ukraine	ЭЛЕКТРОМАГНИТНАЯ РЕШЕТОЧНАЯ «НЕВИДИМОСТЬ» ФОТОННОГО КРИСТАЛЛА ИЗ МАГНИТОДИЭЛЕКТРИЧЕСКИХ СФЕР В ФОРМЕ ОКТАЭДРА
Shafranosh MI Ukraine	Positive Ion Formation Processes When Electrons Interact with Thymine Molecules
<b>Break 14.45-15.00</b>	



19.09.2019 Thursday

**ORAL PRESENTATIONS**

<b>Chairing</b> <b>Dr. Ruken Esra Demirdogen</b>	<b>Hall 1</b> <b>15.00</b>
Tetiana Tykha Ukraine	Use of Wavelet Techniques in the Study of Internet Marketing Metrics
Tetiana Tykha Ukraine	Conversion Marketing Model for Advanced Optimization Tasks
Vusala Muradova Ukraine	Physiological Aspects of Heavy Metal Toxicity in Different Crop Varieties

<b>Chairing</b> <b>Dr. Kozar A.I</b>	<b>Hall 2</b> <b>15.00</b>
Anastasiia Shapovalova Ukraine	Investigation of the Impact of HTTP DoS Attacks on the Cloud Web Server
Igor Grebennik Ukraine	Decision making in information technologies for analysis of scientific and applied problems
O.S. Hnatenko Ukraine	Design and study of a laser system for detecting optical devices



19.09.2019 Thursday

POSTER PRESENTATION SECTION

19.09.2019 Thursday-(14.<sup>00</sup>-16.<sup>00</sup>)

01. Yana Polonska      Adsorption Capacity on Toxic Metals Ions of the Silica Gel Surface, In Situ Modified by poly [8-methacroyloxy quinoline]
02. Elena Kondratenko      Application of 4-vinylpyridine and styrene copolymers and composite materials of natural minerals of Ukraine for the treatment of polluted natural reservoirs and industrial wastewater
03. Meryem Akbelen      Study of FTIR, BET and H<sub>2</sub> Adsorption Properties of Natural and Ion-Exchanged Sepiolite
04. Zafer Dikmen      Comparison of fly ash and red mud mixtures on physical and morphological
05. Tishakova Tetyana      Determination of sialic acid level in blood serum of rats as marker of anti-inflammatory action of pharmaceutical composition containing piroxicam and caffeine
06. E. N. Kovalenko      Absorption Spectra of the RbCl-PbCl<sub>2</sub> System Compounds
07. E. N. Kovalenko      Absorption Spectra of Triple Compounds MPbI<sub>3</sub> (M=Cs, Rb, K) Thin Films
08. Svitlana Kolomiyets      Meteoroids: chemistry, radio engineering and celestial mechanics
09. Olena Nevzorova      The Overview of Method of Balanced Resource Reservation and Multicast Routing in Telecommunication Network
10. Artem Sukhomlinov      Building a System For Logistics Information Systems Evaluation
11. Maryna Miroshnyk      Способы Расширения Рабочей Полосы Частот Для Многозондовой Измерительной Линии Свч





ICONAT 2019

# ABSTRACTS



lifecell

1	<b>Structure of Vortex of Condensed Gas in Trapped Cloud</b> , Utku Kaya, Abidin KILIÇ, <i>Turkey</i> .	19
2	<b>Use of nonlinear optimization algorithm and discrete Fourier transforms to control dermatoscopic examinations</b> , Trubitsin O.O., Avrunin O.G., Klimenko V. A., <i>Ukraine</i> .	20
3	<b>Comparison of segmentation algorithms for treatment of dermatoscopic images of patients with atopic dermatitis</b> , Trubitsin O.O., Avrunin O.G., Klimenko V. A., <i>Ukraine</i> .	22
4	<b>Investigation of the Impact of HTTP DoS Attacks on the Cloud Web Server</b> , Anastasiia Shapovalova, Maryna Yevdokymenko, <i>Ukraine</i> .	25
5	<b>Building A System For Logistics Information Systems Evaluation</b> , Murad OMAROV, Artem SUKHOMLINOV, <i>Ukraine</i> .	26
6	<b>Synthesis of Luffa cylindrica Fibers Modified with Layered Double Hydroxides</b> , Derya KILIC, Ruken Esra DEMIRDOGEN, Aslihan CESUR TURGUT, Tuncay YESILKAYNAK, Fatih Mehmet EMEN, Ali İhsan KARACOLAK, <i>Turkey</i> .	27
7	<b>Semiparametric regression estimates based on some transformation techniques for right-censored data</b> , Dursun Aydın, Ersin Yılmaz, <i>Turkey</i> .	28
8	<b>Optimal Temperature Control in a Batch Polymerization Reactor Using Deadbeat Control</b> Duygu Anaklı, Sevil Çetinkaya, Hale Hapoğlu, <i>Turkey</i> .	29
9	<b>The Effect of the Three Types of Surfactants in the Structure and Properties of Organo-Modified Bentonite Clay</b> , Duygu ANAKLI, <i>Turkey</i> .	30
10	<b>Absorption Spectra of the RbCl-PbCl<sub>2</sub> System Compounds</b> , E. N. Kovalenko, O. N. Yunakova, N. N. Yunakov, S. G. Kravchenko, <i>Ukraine</i> .	31
11	<b>Application of composite materials of 4-vinylpyridine and styrene copolymers and natural minerals of Ukraine for purification of polluted natural reservoirs and industrial sewage</b> , Kondratenko, O. U., Yanovskaya, E. S., Vetik, L. O., Nikolaev, O. A. <i>Ukraine</i> .	32
12	<b>Design and study of a laser system for detecting optical devices</b> , Hnatenko, O. S., Machekhin, Yu. P., Neofitnyi, M.V., Gulak, S.V., <i>Ukraine</i> .	33
13	<b>Optimization of Transport Mobile Communication Network</b> , Hvostyk IHOR, Lubov TOKAR, Yana KRASNOZHENIUK, Al-Vandavi Saif Ahmed ISKANDAR, <i>Ukraine</i> .	34

14	<b>Decision making in information technologies for analysis of scientific and applied problems</b> , Igor Grebennik, <i>Ukraine</i> .	36
15	<b>Microcirculation Evaluation Capabilities Using Capillaroscopy</b> , Kovalova Anastasiia, <i>Ukraine</i> .	38
16	<b>Electromagnetic Lattice “Invisibility” Of A Photon Crystal From Magnetodielectric Spheres In The Form Of Octahedra</b> , Kozar A.I., <i>Ukraine</i> .	41
17	<b>Dynamical Fractal Analysis of the Acoustic Ultra-Wideband Signal Caused by the Chelyabinsk Meteoroid</b> , Andriy A. Onishchenko, Leonid F. Chernogor, Oleg V. Lazorenko, <i>Ukraine</i> .	42
18	<b>Study of FTIR, BET and H<sub>2</sub> Adsorption Properties of Natural and Ion-Exchanged Sepiolite</b> , Meryem Akbelen, <i>Turkey</i> .	43
19	<b>Hydrogen Adsorption Capacities of Natural and Salt Treated Zeolite</b> , Meryem Akbelen, Çağatay Ezber, <i>Turkey</i> .	44
20	<b>Investigation of thermal and structural properties of nitric, hydrochloric and sulphuric acid-treated zeolite</b> , Çağatay Ezber, Meryem Akbelen, <i>Turkey</i> .	45
21	<b>Adoption Of Cloud Computing In Higher Education Sector: An Overview</b> , Mohammad AL RAWAJBEH, Issam ALHADID, Hssan AL-ZOUBI, <i>Jordan</i> .	46
22	<b>Ways To Extend The Frequency Operation Band For The Multi-Probe Measuring Lines Of The Microwave</b> , Miroshnik MA , Zaichenko O.B., <i>Ukraine</i> .	47
23	<b>The Change of Line Ratio of Optical Emission Spectra with Time for Inductive Radio Frequency Argon Discharge at Low Pressure</b> , Murat Tanışlı, <i>Turkey</i> .	48
24	<b>Investigation of Argon Plasma Jets with Spectral Line Intensity Ratio</b> , Murat Tanışlı, Sevinç Yanık, Neslihan Şahin, <i>Turkey</i> .	49
25	<b>Analysis of Restrictions Influence in Implementation of Space-Time Access Methods</b> , Mykola MOSKALETS, Oleksiy SAMOYLENKOV, Kyrlyo KULISH, Kostiantyn SIELIVANOV, <i>Ukraine</i> .	50
26	<b>Characterization of Neon Plasma Jets Generated by Dielectric Barrier Discharge-Like System at Atmospheric Pressure</b> , Neslihan ŞAHİN, Murat TANIŞLI, <i>Turkey</i> .	51
27	<b>Theoretical and Experimental Infrared Spectrum Analysis of Cation of Ionic Liquid 1-Ethyl-3-Methylimidazolium</b> , Nihal KUS, Saliha ILICAN, <i>Turkey</i> .	52
28	<b>Photo-Isomerization Reactions of Oxygen Containing Molecules using Matrix Isolation Spectroscopy</b> , Nihal Kuş, <i>Turkey</i> .	53

29	<b>Method Of Congestion Management And Balanced Resource Allocation On Mpls-Te Telecommunication Network Routers</b> , Oleksandr LEMESHKO, Tetiana LEBEDENKO, <i>Ukraine</i> .	54
30	<b>Development Of An Automated System For Video Dermatoscopy</b> , Olga Isaeva, <i>Ukraine</i> .	55
31	<b>The Overview Of Method Of Balanced Resource Reservation And Multicast Routing In Telecommunication Network</b> , Amal MERSNI, Olena NEVZOROVA, Yelyzaveta TOLSTYKH, <i>Ukraine</i> .	56
32	<b>Investigation of the Xenon and Barium Isotopes</b> RAMESH KUMAR, <i>India</i> .	57
33	<b>Detection of “Wall Thinning” Type Defects in Pipelines by Thermal Method</b> , Roman Orel, Sergey Meshkov, Volodymyr Storozhenko, Aleksandr Myagkiy, <i>Ukraine</i> .	58
34	<b>Supramoleculartheranostic Platforms Goes Green</b> , Ruken Esra DEMIRDOGEN, Derya KILIC, Fatih Mehmet EMEN, Ali İhsan KARACOLAK, Muhammad Asım Ali, Emine KUTLU, Tuncay YESILKAYNAK, Göktürk AVŞAR, <i>Turkey</i> .	59
35	<b>Synthesis of Corchoruscapsularis Fibers Modified with Layered Double Hydroxides and Their Use in Cleaning Waters from Oils</b> , Ruken Esra DEMIRDOGEN, Derya KILIC, Aslıhan CESUR TURGUT, Fatih Mehmet EMEN, Tuncay YESILKAYNAK, Ali İhsan KARACOLAK, Muhammad Asım Ali, Emine KUTLU, Göktürk A VŞAR, <i>Turkey</i> .	60
36	<b>The Study of Classics Particles' Energy at Archimedean Solids with Clifford Algebra</b> , Şadiye ÇAKMAK, Abidin Kılıç, <i>Turkey</i> .	61
37	<b>Effect of Deformation, Particle-Hole And Particle-Particle Interaction on Gamow-Teller Transitions Of <sup>76</sup>Ge</b> , Sadiye Cakmak, Cevad Selam , <i>Turkey</i> .	62
38	<b>Structural Analysis and Photophysical Properties of Proline</b> , Saliha Ilıcan, Nihal Kus, <i>Turkey</i> .	63
39	<b>Fabrication and I-V Characteristics of p-Si/n-ZnO:Er Heterojunctions</b> Gonca Ilgu Buyuk, Saliha Ilıcan, <i>Turkey</i> .	64
40	<b>Mechanical Activation Of Fly Ash: Physical, Mineralogical And Morphological Characterization Of Ground Fly Ashes</b> , Sedef DİKMEN, Zafer DİKMEN, Gülgün YILMAZ, Seyhan FIRAT, <i>Turkey</i> .	65
41	<b>The Information Of The Results' The Of The Physical Size Measurement</b> , Igor Ruzhentsev, <i>Ukraine</i> .	66

42	<b>Green Reduction of Graphene Oxide by Using Kombucha Tea</b> , Sevil Çetinkaya, Nurşah Kütük, Filiz Boran, <i>Turkey</i> .	67
43	<b>Effect of the Synthesis Temperature of Polycarboxylate-based Superplasticizers on the Performance of Concrete</b> , Sevil Çetinkaya, Melih Özduran, Zeynep Haste Özserçe, <i>Turkey</i> .	68
44	<b>Positive Ion Formation Processes When Electrons Interact with Thymine Molecules</b> , Shafranosh M.I., Suhovia M.I., Petruyak V.I., Shafranosh I.I., <i>Ukraine</i> .	69
45	<b>Meteoroids: chemistry, radio engineering and celestial mechanics</b> , Kolomiyets S.V., Kyrychenko I. Yu., <i>Ukraine</i> .	70
46	<b>Use of Wavelet Techniques in the Study of Internet Marketing Metrics</b> , Murad Omarov, Tetiana Tikha, Vyacheslav Lyashenko, <i>Ukraine</i> .	71
47	<b>Conversion Marketing Model for Advanced Optimization Tasks</b> , Tetiana Tykha, <i>Ukraine</i> .	72
48	<b>Determination of sialic acid level in blood serum of rats as marker of anti- inflammatory action of pharmaceutical composition containing piroxicam and caffeine</b> , Syrova G.O., Tishakova T.S., Savelieva O.V., <i>Ukraine</i> .	73
49	<b>Brinell Indentation Diameter Measurement without Using An Optical Microscope</b> , Utku Kaya, <i>Turkey</i> .	75
50	<b>Construction the information systems of knowledge based on service-oriented architecture using neural networks</b> , Murad Omarov, Vusala Muradova, <i>Ukraine</i> .	76
51	<b>Adsorption Capacity on Toxic Metals Ions of the Silica Gel Surface, In Situ Modified by poly[8-methacroyloxy quinoline]</b> , Polonska Y., Yanovska E., Savchenko I., Ol'khovik L., Sternik D, O. Kychkyruk, Kokhan P., <i>Ukraine</i> .	77
52	<b>The information and communication technologies in informatization of The Republic of Azerbaijan's economy</b> , Yusif Gasimov, Asif Pashaev, Bahram Azizov, <i>Azerbaijan</i> .	78
53	<b>New Trends For Type II Superlattices</b> , M. Hostut, A. Kılıç, Y. Ergun, <i>Turkey</i> .	79
54	<b>Smart Grid Integreted With Hybrid Renewable Energy Systems</b> , Zafer Demir, Omer Aydın, <i>Turkey</i> .	80

55	<b>Comparison of fly ash and red mud mixtures on physical and morphological characteristics,</b> Zafer Dikmen, Sedef Dikmen, <i>Turkey.</i>	81
56	<b>Numerical Error Analysis For Configurable Cell Segmentation Problem,</b> Nataliya BILOUS, Oleg HRAMM, Iryna AHEKIAN, Abed Thamer KHUDHAIR, Ludmila ILLYASHENKO, Alexander NERUKH, Ukraine.	82
57	<b>The relationship between headache types and blood groups and socioeconomics factors,</b> Ali Jabbar Al Lemane, <i>Lebanon.</i>	83
58	<b>Application of Machine Learning Systems to Bioinformatic Resources,</b> Len Si Hian, <i>China.</i>	84
59	<b>Some Models of Mechanical and Thermal Properties of Skin in the Context of Plastic Surgery,</b> A.E. Kokorev, A.O. Kiriak, O.G. Avrunin, Ukraine.	85
60	<b>Flexible Manufacturing Tendencies and Improvements with Visual Sensoring,</b> Artem BRONNIKOV, Igor NEVLIUDOV, Oleksandr TSYMBAL, Ukraine.	86
61	Absorption Spectra of Triple Compounds MPbI <sub>3</sub> (M=Cs, Rb, K) Thin Films. E. N. Kovalenko, O. N. Yunakov, N. N. Yunakov, Ukraine	87
62	<b>Photo-Isomerization Reactions of Oxygen Containing Molecules using Matrix Isolation Spectroscopy,</b> Nihal Kus, Turkey (Full Text)	89

# Structure of Vortex of Condensed Gas in Trapped Cloud

Utku Kaya

Abidin KILIÇ

Eskisehir Technical University, Eskisehir, Turkey.

\*abkilig@eskisehir.edu.tr

## ABSTRACT

Bose-Einstein condensation, which has a very low particle density and a highly complex quantum structure, has been experimentally proven to date for rubidium, sodium, lithium, hydrogen, metastable helium, cesium and chromium atoms. Due to the differences between the properties and binary interactions of these atoms, experimental studies on condensation have found many impressive results. The structure of a vortex in a trapped environment and the factors affecting it were investigated in this study. Angular Momentum was calculated using Thomas-Fermi Approach.

Key words: Bose-Einstein Condensation, Vortex, Dynamics of Condensation

## Використання алгоритму нелінійної оптимізації та дискретних перетворень Фур'є для контролю проведення дерматоскопічне досліджень

асп. Трубіцин О.О.1, д.т.н., проф. Аврунін О.Г.1, д.м.н., проф. Клименко В.А.2  
1 каф. Біомедичної інженерії, Харківський національний університет  
радіоелектроніки, e-mail: d\_bme@nure.ua, м. Харків, Україна.  
2 каф. Пропедевтики педіатрії №2, Харківський національний медичний  
університет, e-mail: klymenkoviktoria@gmail.com, м. Харків, Україна.

У статті розглянута проблема визначення помилки зсуву досліджуваної ділянки шкіри при проведенні дерматоскопічного дослідження хворого на atopічний дерматит за допомогою алгоритму нелінійної оптимізації та дискретних перетворень Фур'є. Отримано результати обчислень відстані помилки зсуву досліджуваної ділянки поверхні шкіри.

**Ключові слова:** Атопічний дерматит, дерматоскопічне дослідження, стан шкіри, дискретні трансформації Фур'є

1. **Стан проблеми.** Атопічний дерматит (АтД) є хронічним запальним захворюванням шкіри, яке в більшості випадків розвивається у осіб зі спадковою схильністю, часто поєднується з іншими алергічними захворюваннями такими, як бронхіальна астма, алергічний риніт, харчова алергія. АтД часто починається в дитячому віці і є причиною сильного свербіжу, а також косметичних дефектів шкіри.

Останнім часом для моніторингу стану уражених ділянок шкіри при АтД все частіше використовуються дерматоскопічне дослідження. При обстеженні ураженої ділянки шкіри портативним дерматоскопом існує ймовірність отримання похибки, пов'язаної з випадковим зміщенням меж досліджуваної ділянки, що може стати причиною помилок при подальшому аналізі дерматоскопічних знімків [1, 2]. З метою контролю точності проведеного моніторингу досліджуваних ділянок шкіри необхідно застосовувати методи, здатні оцінити помилку зсуву досліджуваних ділянок при проведенні дерматоскопічних досліджень [3, 4].

2. **Матеріали та методи.** Для дослідження було взято дерматоскопічний знімок хворого, що проходив обстеження і лікування на базі кафедри Пропедевтики педіатрії №2 Харківської обласної дитячої клінічної лікарні №1. В якості математичного апарату для визначення помилки зсуву досліджуваної ділянки був використаний алгоритм нелінійної оптимізації та дискретних перетворень Фур'є [5, 6]. Алгоритм був реалізований на мові програмування Python, за допомогою програмної бібліотеки Scikit-image [7, 8].

3. **Результати досліджень.** За допомогою алгоритму нелінійної оптимізації та дискретних перетворень Фур'є була визначена відстань зсуву досліджуваної області в пікселях рис. 1. Результати обчислень наведені у таблиці 1.

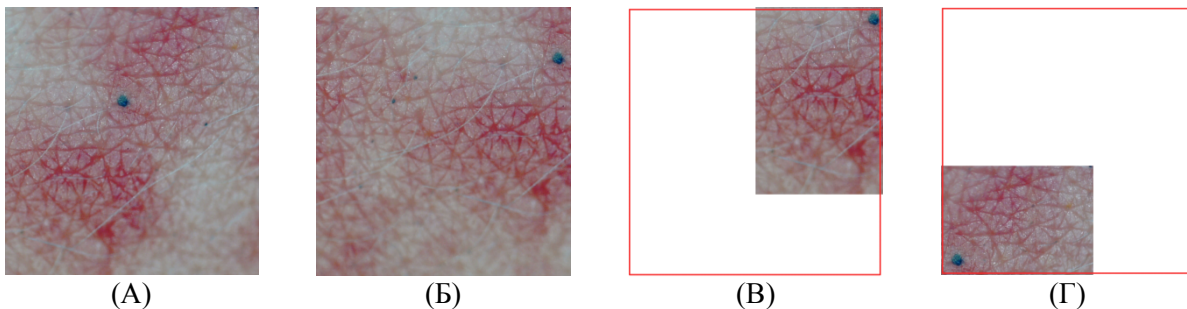


Рисунок 1. Дерматоскопічний знімок ділянки шкіри: (А) вихідне зображення; (Б-Г) зображення, зміщене на певну відстань.



Таблиця 1. Величина помилки зсуву при дослідженні ділянки шкіри

	Відстань зсуву по о Y,X (пікселі)
Зображення Б)	180, -516
Зображення В)	376, -430
Зображення Г)	-119, 2

Визначення помилки зсуву досліджуваної ділянки шкіри є важливим фактором проведення дерматоскопічних досліджень хворих на АтД, при плануванні лікування [9] та при спостереженні динаміки прояв захворювання. Запропонований підхід може використовуватися при підвищенні стійкості алгоритмів обробки зображень та побудові автоматизованих інформаційно-діагностичних систем.

#### Перелік використаних джерел:

- [1] Аврунин, О. Г. Определение степени инвазивности хирургического доступа при компьютерном планировании оперативных вмешательств / О. Г. Аврунин, М. Ю. Тымкович, Х. И. Фарук // Бионика интеллекта. – 2013. – № 2 (81). – С. 101–104.
- [2] Худаева С. А. Особенности цифровой обработки биомедицинских изображений / С. А. Худаева, Абделхамид Ибрахим Юнус, Ханькунь Цзяо // Всеукраїнської науково-практичної конференції молодих учених, курсантів та студентів «Авіація, промисловість, суспільство» – Кременчук, 2019. – С. 270 – 273
- [3] Аврунин О. Г. Опыт разработки биомедицинской системы цифровой микроскопии / О. Г. Аврунин // Прикладная радиоэлектроника. – 2009. – Т.8. – № 1. – С. 46 – 52.
- [4] Худаева С. А. Возможности денситометрического анализа при диагностике риносинуситов / С. А. Худаева, О. Г. Аврунин // Матеріали 23 Міжнародного молодіжного форуму. Т. 1. – Харків: ХНУРЕ. 2019. – С. 241 – 242.
- [5] Guizar-Sicairos M. Efficient subpixel image registration algorithms / M. Guizar-Sicairos, S. T. Thurman, J. R. Fienup // Optics Letters. – 2008. – Vol. 33. – № 2.
- [6] Аврунин О.Г., Жемчужкина Т.В., Носова Т.В. Автоматизированный анализ количественных показателей треморографических данных для наблюдения динамики тремора» // Восточно-Европейский журнал передовых технологий. – 2011. – № 2/2 (50). – С. 17-21.
- [7] Emmanuelle Guillard Analyzing microtomography data with Python and the scikit- image library / Emmanuelle Guillard, Juan Nunez- Iglesias, Stéfan van der Walt3 // Guillard et al. Adv Struct Chem Imag. -- 2016. -- Т.2 - №8. -- P. 2 -- 11.
- [8] Книгавко, Ю.В. Алгоритмы программного рендеринга трехмерной графики для задач медицинской визуализации / Ю.В. Книгавко, О.Г. Аврунин // Журн. Технічна електродинаміка-2010. – С. 258-261.
- [9] Сипитый В.И., Пятикоп В.А., Кутовой И.А., Аврунин О.Г. Опыт проведения стереотаксических расчетов с использованием интраоперационной компьютерной томографии / В. И. Сипитый, В. А. Пятикоп, И. А. Кутовой, О. Г. Аврунин // Український нейрохірургічний журнал.– 2006. – № 3. – С. 58–62.

## Порівняння алгоритмів сегментації при обробці дерматоскопічних зображень хворих на атопічний дерматит

асп. Трубіцин О.О.1, д.т.н., проф. Аврунін О.Г.1, д.м.н., проф. Клименко В.А.2

1 каф. Біомедичної інженерії, Харківський національний університет радіоелектроніки, e-mail: d\_bme@pufe.ua, м. Харків, Україна.

2 каф. Пропедевтики педіатрії №2, Харківський національний медичний університет, e-mail: klymenkoviktoriiia@gmail.com, м. Харків, Україна.

У статті досліджено можливості алгоритмів Felzenszwalb's efficient graph based segmentation, Quickshift image segmentation, SLIC, Compact watershed segmentation для сегментації дерматоскопічних знімків дітей з атопічним дерматитом. Проведено аналіз отриманих результатів.

**Ключові слова:** Атопічний дерматит, дерматоскопічне дослідження, стан шкіри, алгоритми сегментації

1. **Стан проблеми.** На даний час одним з основних завдань, що вирішуються в процесі аналізу дерматоскопічних знімків хворих на атопічний дерматит (АтД), є застосування і подальший аналіз результатів сегментації зображень.

Більшість стандартних алгоритмів обробки реалізовані у вигляді регулярної піксельної сітки, що не завжди оптимально для організації подальшої обробки [1, 2]. В цьому плані відносно новим є підхід, заснований на так званій суперпіксельній сегментації (СС) [3, 4]. СС розбиває зображення на безліч дрібних фрагментів (суперпікселей), що представляють відносно однорідні групи розташованих поруч пікселів, де кожен суперпіксель розглядається як окремий регіон зображення [5, 6].

Основною вимогою до суперпіксельної сегментації є максимальна схожість пікселів всередині кожного однорідного регіону зображення. Для вирішення даного завдання розроблений цілий ряд методів. При цьому результат суперпіксельної сегментації може істотно відрізнитися в залежності від використовуваного підходу [7, 8].

Наступним важливим етапом обробки і аналізу дерматоскопічних знімків є завдання оцінки результатів сегментації. Ряд авторів [9, 10] методи оцінки сегментації поділяють на два основні класи: суб'єктивні і об'єктивні критерії.

До суб'єктивних відносять критерії, отримані в процесі візуального аналізу сегментованої ділянки зображення групою експертів. До об'єктивних відносять критерії, отримані без аналітичної оцінки експертами.

Об'єктивні критерії володіють перевагами та недоліками. Так, критерії, засновані на визначенні відмінностей сегментованого зображення і еталонної сегментації, дають більш точні оцінки; критерії, які безпосереднього оцінюють властивості сегментованого об'єкта, можуть використовуватися в системах реального часу, проте вони є менш точними [11].

2. **Матеріали та методи.** У даній роботі проведено дослідження алгоритмів сегментації: Felzenszwalb's efficient graph based segmentation, Quickshift image segmentation, SLIC, Compact watershed segmentation при обробці дерматоскопічних зображень хворого з АтД, що проходив обстеження і лікування на базі кафедри Пропедевтики педіатрії №2 Харківської обласної дитячої клінічної лікарні №1. Реалізація алгоритмів була виконана на мові Python за допомогою програмної бібліотеки Scikit-image.

3. **Результати дослідження.** В ході досліджень були отримані зображення дерматоскопічного знімку після застосування алгоритмів сегментації рис. 1.

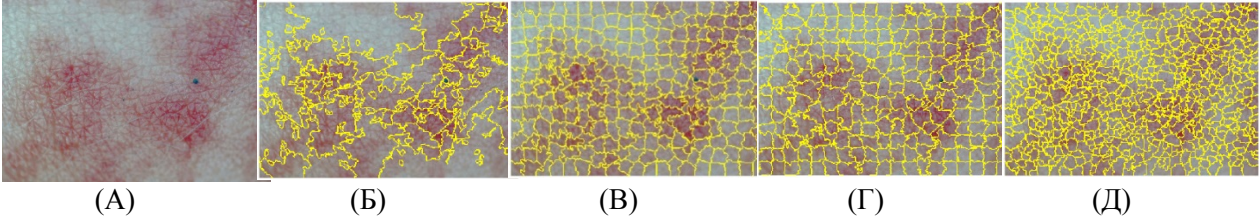


Рисунок 1. Реалізація алгоритмів сегментації: (А) досліджуване зображення, (Б) Felzenszwalb's efficient graph based segmentation, (В) SLIC, (Г) Compact watershed segmentation, (Д) Quickshift image segmentation.

Суб'єктивні методи продовжують залишатися – найбільш універсальними і широко використовуваними. Пов'язано це з порівняльною простотою і гнучкістю аналізу отриманих результатів сегментації. Крім того, суб'єктивні методи оцінки якості сегментації зображень, в основному, не вимагають наявності еталонного зразка сегментації.

Стосовно до задачі аналізу сегментації дерматоскопічного знімку можна сформулювати ряд ознак «якісної» сегментації: 1) всередині досліджуваної ділянки число сегментів має бути мінімально достатнім; 2) межі сегментів повинні бути гладкими і мати точну просторову локалізацію; 3) відстань між кордоном досліджуваної області і контуром сегментної сітки має бути мінімальною.

Аналіз результатів алгоритмів сегментації показує, що зображення (Б) має мінімальне число сегментів, в той же час кордони досліджуваної області визначені найменш чітко; зображення (Д) має надлишкову кількість сегментів, що ускладнює аналіз контуру досліджуваної області. Найбільш інформативними можуть бути зображення (В) і (Г), проте контури сегментів мають складну геометричну форму, що може стати причиною надмірних обчислювальних витрат при подальшій автоматизованій обробці знімків.

**Висновки.** В ході дослідження були визначені проблеми оцінки використання алгоритмів сегментації, обґрунтований метод оцінки сегментації, проаналізовано роботу алгоритмів сегментації для виділення окремих ділянок дерматоскопічного знімку хворого на АтД.

Подальшими кроками досліджень може бути розробка методики формування оптимального набору критеріїв оцінки якості сегментації дерматоскопічних знімків уражених ділянок шкіри хворих на АтД.

#### Перелік літератури:

- [1] Саввин С. В. Методы суперпиксельной сегментации и их применение для анализа изображения с разной текстурой / С. В. Саввин, А. А. Сирота // Вестник ВГУ, серия: системный анализ и информационные технологии. – 2016. -- №4. – С. 165 – 173.
- [2] Книгавко, Ю.В. Программная визуализация объемных медицинских данных / Ю.В. Книгавко, О.Г. Аврунин // Журн. Техн. электродинамика – 2011. – С. 301-308.
- [3] Аврунин О. Г. Опыт разработки программного обеспечения для визуализации томографических данных / О. Г. Аврунин // Вісник НТУ «ХПІ». – 2006. – № 23. – С. 3 – 8.
- [4] Аврунин О. Г. Опыт разработки биомедицинской системы цифровой микроскопии / О. Г. Аврунин // Прикладная радиоэлектроника. – 2009. – Т.8. -- № 1. – С. 46 – 52.
- [5] Аврунин О.Г. Определение степени инвазивности хирургического доступа при компьютерном планировании оперативных вмешательств / О.Г. Аврунин, М.Ю. Тымкович., Х. Фарук // Бионика интеллекта. – 2013. – № 2 (81). – С. 101 – 104.
- [6] Шамраева О. О. Выбор метода сегментации костных структур на томографических изображениях/ Е. О. Шамраева, О. Г. Аврунин // Бионика интеллекта. – 2006. – № 2 (65). – С.83–87.

- [7] Avrunin O.G., Nosova Y.V., Shuhlyapina N.O., Zlepko S.M., Tymchyk S.V., Hotra O., Imanbek B., Kalizhanova A., Mussabekova A., Principles of computer planning in the functional nasal surgery. *Przegląd Elektrotechniczny* 93(3)/2017, 140-143.
- [8] Сипитый В.И., Пятикоп В.А., Кутовой И.А., Аврунин О.Г. Опыт проведения стереотаксических расчетов с использованием интраоперационной компьютерной томографии / В. И. Сипитый, В. А. Пятикоп, И. А. Кутовой, О. Г. Аврунин // *Український нейрохірургічний журнал.*—2006. — № 3. — С. 58–62.
- [9] Березский О.Н. Количественная оценка качества сегментации изображений на основе метрик / О.Н. Березский, Е.Н. Березская // *УСиМ.*—2015. — № 6. — С. 60 - 66.
- [10] Критерии оценки качества сегментации изображений / А. В. Захаров [и др.] // *Труды НИИСИС РАН.* — 2012. —Т 2. — № 2. С. 87 – 99
- [11] Книгавко, Ю.В. Алгоритмы программного рендеринга трехмерной графики для задач медицинской визуализации / Ю.В. Книгавко, О.Г. Аврунин // *Журн. Технічна електродинаміка.*—2010. — С. 258-261.

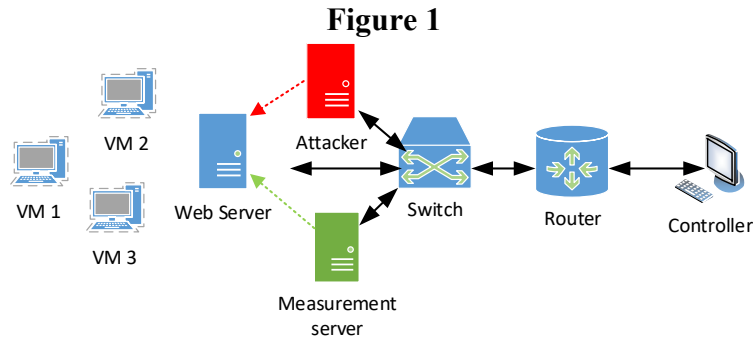
# Investigation of the Impact of HTTP DoS Attacks on the Cloud Web Server

Anastasiia Shapovalova\*, Maryna Yevdokymenko

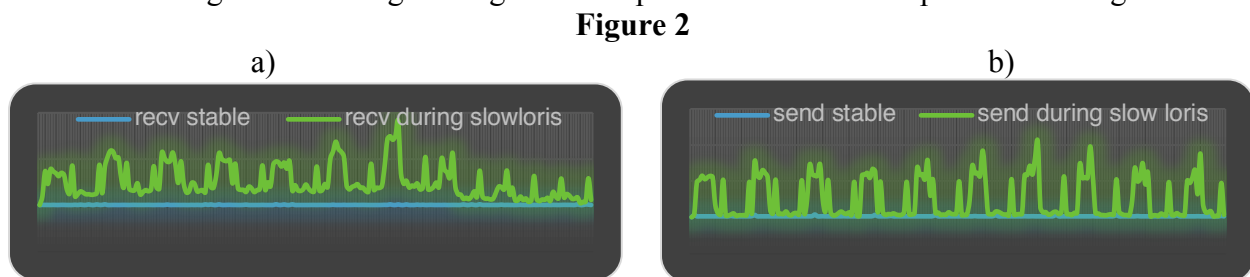
V.V. Popovskyy Department of Infocommunication Engineering,  
Kharkiv National University of Radio Electronics  
Kharkiv, 14 Nauky Ave., Ukraine  
Kharkiv  
Ukraine

Email of corresponding author: anastasiia.shapovalova@nure.ua

This paper presents research into the impact of HTTP DoS Attacks on Cloud Web Server. For the experiment, we used a virtual environment consisting of a Web server, an attacking server, a controller, and a server that measures the effect of HTTP DoS Attacks on the functioning of the attacked web server in terms of network resource consumption. The experimental scheme is shown in Fig. 1.



The initial data was: the number of calls to the server - 5000, 25 connections per second and Content-Length header value - 4096. The measurements were carried out in two modes: the mode of sending and receiving messages. The experimental results are presented in Fig. 2.



Received messages in the normal state (fig.2. a) amounted to 521.89 bytes, and during the attack – 23744.23 bytes, and when sending messages (fig.2. b) the values were 170 bytes in the normal mode and 10403 bytes in the attack mode for the initial data. These results allow to evaluate the available network resource and the moment of web server overload.

## References

- [1] B.B. Gupta, O.P. Badve, *Taxonomy of DoS and DDoS attacks and desirable defense mechanism in a Cloud computing environment. Neural Comput. Appl.* 2016, 1-28.
- [2] R.R. Zebari, S.R.M. Zeebaree, K. Jacksi, *Impact Analysis of HTTP and SYN Flood DDoS Attacks on Apache 2 and IIS 10.0 Web Servers, ICOASE, Duhok*, 2018, 156-161.

# **BUILDING A SYSTEM FOR LOGISTICS INFORMATION SYSTEMS EVALUATION**

Murad OMAROV<sup>1</sup>, Artem SUKHOMLINOV<sup>2</sup>

<sup>1</sup> Kharkiv National University of Radio Electronics, Kharkiv, Ukraine

<sup>2</sup> Kharkiv National University of Radio Electronics, Kharkiv, Ukraine

## **ABSTRACT**

The article analyzes the criteria by which to evaluate the logistics systems and shows the process of forming a system of logistics information systems evaluation, based on the criteria used by qualitative scales. The article also analyzes modern technologies of information systems development, in particular the technology of object-relational mapping. There has been considered the application of the built evaluation system in the research logistics information system.

**Keywords:** logistics system; evaluation criterion; material flow; multiset model of material flow.

# Synthesis of *Luffa cylindrica* Fibers Modified with Layered Double Hydroxides

Derya KILIC<sup>1\*</sup>, Ruken Esra DEMIRDOGEN<sup>2</sup>, Aslihan CESUR TURGUT<sup>3</sup>, Tuncay YESILKAYNAK<sup>4</sup>, Fatih Mehmet EMEN<sup>1</sup>, Ali İhsan KARACOLAK<sup>1</sup>

<sup>1</sup>Faculty of Arts and Science, Department of Chemistry, Burdur Mehmet Akif Ersoy University, Burdur, TURKEY

<sup>2</sup>Faculty of Science, Department of Chemistry, Cankiri Karatekin University, Cankiri, TURKEY

<sup>3</sup>Science, Technology and Application and Research Center, Burdur Mehmet Akif Ersoy University, Burdur, TURKEY

<sup>4</sup>Department of Chemistry Technology, Afsin Vocational School, Sütcü Imam University, TR46500, Kahramanmaraş, Turkey

Email of corresponding author: klc.derya13@gmail.com

Protection of water resources, cleaning them from pollutants and improving their quality has great economic and ecological importance. Chemical method of cleaning and adsorption is reported to be one of the most effective and efficient method for cleaning [1,2]. Among the adsorbents Layered Double Hydroxide (LDH)-represented with the general formula  $[MII_{1-x} MIII_x(OH)_2] X^+ (Ln^-)_{x/n} mH_2O$ - offers high adsorption efficiency and easy recovery properties. Here  $M^{+2}$  ( $Mg^{2+}$ ,  $Ca^{2+}$ ,  $Ni^{2+}$ ,  $Fe^{2+}$ ,  $Zn^{2+}$ ,  $Cd^{2+}$ ,  $Cu^{2+}$ , ...) and  $M^{+3}$  ( $Al^{3+}$ ,  $Fe^{3+}$ ,  $Cr^{3+}$ , ...) cations fill the octahedral gaps between the brucite like  $(Mg(OH)_2)^-$  layers and the Ln- anion is situated in the hydrated interlayer galleries. LDH's appear as promising structures in phytoremediation for removal of pollutants.

In this study, *Luffa cylindrica* (L.) syn *Luffa aegyptiaca* Mill fibers, which have hydrophilic properties, appropriate pore fiber structure and cellulose and lignin content, will be used. New LDH's with the formula  $[M^{2+}_{1-x}M^{3+}_x(OH)] CO_3^{2-x/2}$ :  $M^{2+}$ :  $Mg^{2+}$ ;  $M^{3+}$ :  $V^{3+}$ ] will be synthesized via controlled precipitation method. Then LDH-plant fiber composites taken from the reactor were modified with sodium laurel sulphates (SLS) to give hydrophobic plant fiber-LDH-SLS composite materials. The composite materials thus prepared are characterized via FT-IR, XRD, SEM-EDS and BET techniques and are shown to have potential to be used in sorption of oil from polluted water sources.

\*This study was supported by TÜBİTAK under the Project number of 118Z008.

## References

- [1] Chen, C., Gunawan, P., Xu, R. *J. Mater. Chem.* **2011**, 21(4), 1218-1225.
- [2] Singh, S., Barick, K. C., Bahadur, D. *J. Haz. Mater.* **2011**, 192(3), 1539-1547.

# Semiparametric regression estimates based on some transformation techniques for right-censored data

Dursun Aydın, Ersin Yılmaz\*

Department of Statistics, Faculty of Science, Mugla Sitki Kocman University, 48000  
Mugla/ Mentese  
Turkey

Email of corresponding author: yilmazersin13@hotmail.com

In this paper, we introduce three different data transformation approaches such as synthetic data transformation (Buckley and James, 1979; Koul *et al.* 1981; Leurgans, 1987), Kaplan-Meier weights (Kaplan and Meier, 1958; Miller, 1976; Stute, 1993) and  $k$ -nearest neighbor ( $k$ NN) imputation method (Batista and Monard, 2002) which are commonly used in censored data applications. The aforementioned approaches are particularly useful when one deals with censored data. The key idea expressed here is to find the smoothing spline estimates for the parametric and nonparametric components of a semiparametric regression model with right censored data. The estimation is then carried out based on the modified (or transformed) data set obtained via these transformation techniques. In order to compare the outcomes of three approaches in semi-parametric regression setting, we carried out a simulation study. According to the results of the simulation, it can be said that the Kaplan-Meier weights has been very successful in dealing with censored observations.

## References

- [1] J. Buckley, I. James, Linear Regression with Censored Data, *Biometrika*, **1979**, 66(3), 429-436.
- [2] H. Koul, V. Susarla, J. Van Ryzin, Regression Analysis with Randomly Right-Censored Data, *The Annals of Statistics*, **1981**, 1276-1285.
- [3] S. Leurgans, Linear Models, Random Censoring and Synthetic Data, *Biometrika*, **1987**, 74, 301-309.
- [4] E.L. Kaplan, P. Meier, Nonparametric Estimation from Incomplete Observations, *Journal of the American Statistical Association*, **1958**, 53(282), 457-481.
- [5] R.G. Miller, Least Squares Regression with Censored Data, *Biometrika*, **1976**, 63, 449-464.
- [6] W. Stute, Consistent Estimation under Random Censorship when Covariables are Present, *Journal of Multivariate Analysis*, **1993**, 45, 89-103.
- [7] G.E.A.P.A. Batista and M.C. Monard, K-Nearest Neighbour as an Imputation Method: Experimental Results, *Technical Report, ICMC-USP*, **2002**, ISSN-0103-2569.



# Optimal Temperature Control in a Batch Polymerization Reactor Using Deadbeat Control

Duygu Anaklı<sup>1</sup>, Sevil Çetinkaya<sup>1\*</sup>, Hale Hapoğlu<sup>2</sup>

<sup>1</sup>Cumhuriyet University, Department of Chemical Engineering, 58140, Sivas/Turkey

<sup>2</sup>Ankara University, Department of Chemical Engineering, 06100, Ankara/Turkey

\*[cetinkaya.sevil@gmail.com](mailto:cetinkaya.sevil@gmail.com)

Physical, chemical and mechanical properties of polymers are generally nearly related with their molecular weights. Low molecular weight polymers have ineffectual molecular properties and they interact with different chemicals. The full molecular weight distribution (MWD) of a specific polymer and ratio of moments of this distribution, such as the number average ( $M_n$ ) or the weight average ( $M_w$ ) molecular weight, are effective on the mechanical properties of the polymers. Polymers with small molecules whose molecular weight does not exceed a certain value readily interact with various chemicals and have poor mechanical properties. Therefore, the molecular weight of the polymers is very important according to the field of use [1-2].

In this study, Deadbeat control of a jacketed batch reactor in which styrene polymerization occurs under isothermal conditions reactor has been investigated experimentally and by simulation to achieve a specific constant number average chain length and conversion in a minimum time. Also, the effects of different optimal conditions were examined on monomer conversion, average viscosity molecular weight and chain length. It was founded that Deadbeat control provided a good performance in maintaining the reactor temperature at its set point at the isothermal conditions [3].

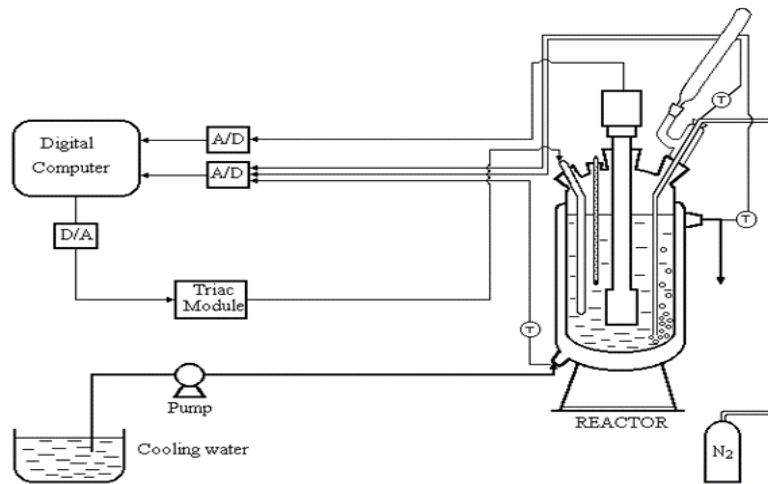


Figure 1. Experimental System

## References

- [1] H. Tobita, Processes. 2015, 3, 731-748.
- [2] H. Tobita, J. Polym. Sci. Part B: Polym. Phys. 2001, 39, 391-403.
- [3] S. Cetinkaya, Z. Zeybek, H. Hapoglu, M. Alpbaz Comput and Chem.l Engin. 2006, 30, 1315-1323.

# The Effect of the Three Types of Surfactants in the Structure and Properties of Organo-Modified Bentonite Clay

Duygu ANAKLI \*

Department of Chemical Engineering, Sivas Cumhuriyet University, 58140, Sivas/Turkey  
\*danakli80@gmail.com

Bentonite with the three-phase crystalline structure is a hydrophilic clay-mineral and mainly constituted by the montmorillonite clay [1]. Depending on its exfoliation ability with the medium, bentonite is used in many industrial applications especially such as ceramics, adhesives, catalysts, cosmetics and pharmaceutical uses [2]. In order to obtain new clay application areas and inorganic-organic nanocomposites the interactions of surfactant-clay are the most important point. For this reason, exfoliation method is used for the modification of clay with the surfactants to enhance the interaction of the clay with the medium [1]. Organoclays are obtained as a result of the reaction of the clay mineral with an alkyl ammonium salt, under suitable conditions.

In this study organo-modified bentonite clays were obtained firstly with purification step, then synthesized with the sequential mixture of cationic surfactants; namely long chained (cetyltrimethylammonium bromide-CTAB), short chained (tetraethylammonium bromide-TEAB) and ringed (benzyltriethylammonium bromide-BTEAB) surfactants. The modified organoclays were characterised by X-ray diffraction (XRD), Fourier transform infrared (FTIR) spectrometry, Scanning Electron Microscopy (SEM) and zeta potential analysis. It was seen that the highest value of basal spacing of the organoclay was obtained by (CTAB+BTEAB) surfactants. The synergistic effect of the surfactants on the interlayer space of the organoclay in terms of developing novel clay based nanocomposites was investigated.

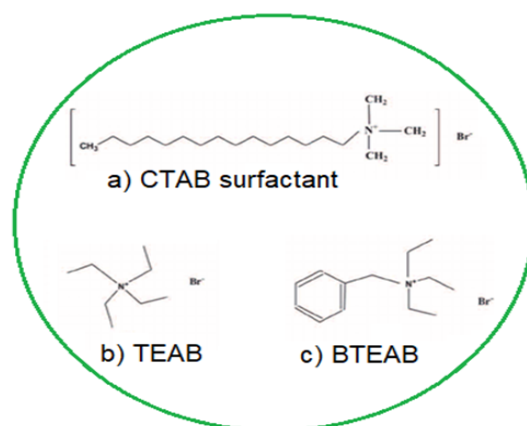


Figure 1. The cationic surfactants used in the process

## References

- [1] M.K.S. Monteiro, V. R. L.Oliveria, F. K. G. Santos, E. L. B. Neto, *J. Mol. Liquids*, **2018**, 272, 990-998.
- [2] C.M. Q-Plamondon, J.Stasiak, A.A-Tabbaa, *Colloids and Surfaces A: Physicochem. Eng. Aspects*, **2014**, 330-337.

## Absorption Spectra of the RbCl-PbCl<sub>2</sub> System Compounds.

E. N. Kovalenko<sup>a</sup>, O. N. Yunakova<sup>b</sup>, N. N. Yunakov<sup>b</sup>, S. G. Kravchenko<sup>a</sup>.

<sup>a</sup>Kharkiv National University of Radio Electronics,  
Nauka Ave., 14, 61166,  
Kharkiv, Ukraine

<sup>b</sup>V. N. Karazin Kharkiv National University,  
Svobody Sq., 4, 61022,  
Kharkiv, Ukraine

It is known that out of 5 compounds formed in the system RbCl-PbCl<sub>2</sub> only RbPb<sub>2</sub>Cl<sub>5</sub> and Rb<sub>6</sub>Pb<sub>5</sub>Cl<sub>16</sub> are stable at room temperature. First compound crystallizes into an orthorhombic lattice at 20°C with lattice parameters  $a=8.992 \text{ \AA}$ ,  $b=7.996 \text{ \AA}$ ,  $c=12.54 \text{ \AA}$ ,  $\gamma=90^\circ$ ,  $z=4$ , and second crystallizes into a tetragonal structure with lattice parameters  $a=11.855 \text{ \AA}$ ,  $c=11.237 \text{ \AA}$ ,  $z=4$ .

The absorption spectra of thin RbPb<sub>2</sub>Cl<sub>5</sub> and Rb<sub>6</sub>Pb<sub>5</sub>Cl<sub>16</sub> films were studied in the spectral range 2-6 eV and the temperature interval 90-500 K. The binding energy of excitons and the width of the forbidden band in both compounds are determined.

The absorption spectra of RbPb<sub>2</sub>Cl<sub>5</sub> and Rb<sub>6</sub>Pb<sub>5</sub>Cl<sub>16</sub> (fig. 1) are close to the spectrum of PbCl<sub>2</sub> and the spectra of impurity bands of Pb<sup>2+</sup> in RbCl (table 1) by structure and position of

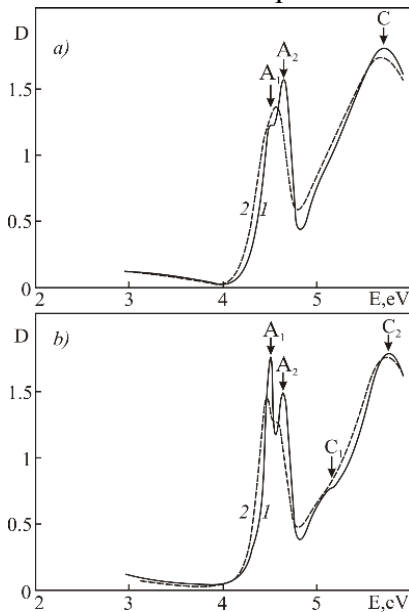


Fig. 1. The absorption spectrum of a thin film of RbPb<sub>2</sub>Cl<sub>5</sub> (a) ( $t=75 \text{ nm}$ ) and a thin film of Rb<sub>6</sub>Pb<sub>5</sub>Cl<sub>16</sub> (b) ( $t=75 \text{ nm}$ ) at  $T = 90\text{K}$  (1) and  $T=290 \text{ K}$  (2).

the bands. Accordingly, the excitons in these compounds, as well as in PbCl<sub>2</sub> and RbCl: Pb<sup>2+</sup>, have a cation type and the exciton spectrum is interpreted on the basis of transitions in the Pb<sup>2+</sup> ion. In contrast to PbCl<sub>2</sub>, two long-wavelength excitonic bands A<sub>1</sub> and A<sub>2</sub> are observed in the spectra of RbPb<sub>2</sub>Cl<sub>5</sub> and Rb<sub>6</sub>Pb<sub>5</sub>Cl<sub>16</sub>, which happens due to presence of two non-equivalent Pb1 ion positions surrounded by various number of Cl ions inside crystal lattice.

The two-dimensional (2D) nature of the excitons in RbPb<sub>2</sub>Cl<sub>5</sub> and three-dimensional (3D) in Rb<sub>6</sub>Pb<sub>5</sub>Cl<sub>16</sub> is established from the analysis of the temperature dependences of  $\Gamma_1(T)$  and  $\Gamma_2(T)$  of long-wave exciton bands A<sub>1</sub> and A<sub>2</sub>, which agrees with the structure of the crystal lattices of the compounds.

Table 1. The spectral position of the exciton bands, the band gap  $E_g$  and the binding energy of the exciton  $R_{ex}$  in the compounds RbPb<sub>2</sub>Cl<sub>5</sub>, Rb<sub>6</sub>Pb<sub>5</sub>Cl<sub>16</sub> ( $T=90\text{K}$ ), PbCl<sub>2</sub> and RbCl:Pb<sup>2+</sup>.

Compound	$E_{mA1}$ , eV	$E_{mA2}$ , eV	$E_{mC1}$ , eV	$E_{mC2}$ , eV	$E_g$ , eV	$R_{ex}$ , eV
RbPb <sub>2</sub> Cl <sub>5</sub>	4.465	4.627		5.7	4.68	0.22
Rb <sub>6</sub> Pb <sub>5</sub> Cl <sub>16</sub>	4.475	4.63	5.12	5.7	4.73	0.25
PbCl <sub>2</sub>	4.68			5.77	4.86	0.18
RbCl:Pb <sup>2+</sup>	4.582		5.85	6.192		

## Застосування композитних матеріалів кополімерів 4-вінілпіридину і стирену та природних мінералів України для очищення забруднених природних водойм та промислових стічних вод

**О.У. Кондратенко<sup>1</sup>, Е.С. Яновська\*<sup>2</sup>, Л.О. Вретік<sup>2</sup>, О.А. Ніколаєва<sup>2</sup>**

<sup>1</sup>Житомирський державний університет імені Івана Франка, м.Житомир / Україна

<sup>2</sup>Київський національний університет імені Тараса Шевченка, м.Київ / Україна

email: elina\_yanovska@ukr.net

Сучасні методи очищення забрудненої води, на наш погляд, повинні бути максимально наближені до природних. А природою створені безпечні методи очищення води, що полягають у адсорбції антропогенних забруднювачів при проходженні забрудненої води через горизонти мінералів (глин, силікатів та алюмосилікатів, цеолітів тощо) і дозволяють зберегти її структуру та мінералізацію. Цей механізм забезпечував кругообіг речовин між геосферами планети протягом мільярдів років. Тому його розумне використання повинно лягти в основу найсучасніших технологій очищення водних ресурсів та переробки відходів, які можна перевести у розчинну форму. У якості екологічно безпечних адсорбентів-очисників стічних вод доцільно використовувати такі природні мінерали України, як Подільський сапоніт (сапонітова глина), Закарпатські кліноптилоліти, бентоніт, вермикуліт, що відомі не тільки своїми хорошими адсорбційними характеристиками, а й лікувальними та цілющими властивостями.

Модифікація поверхні поруватих неорганічних матеріалів полімерами з комплексотвірними властивостями дозволяє отримати сорбенти для вилучення зі стічних вод іонів токсичних металів. Такі композити поєднують кращі властивості неорганічних та полімерних сорбентів: не набухають, характеризуються високою швидкістю сорбції, виявляють високу сорбційну ємність на рівні полімерів.

Одним з перспективних шляхів створення органо-мінеральних композитних матеріалів з цінними сорбційними властивостями є полімеризаційна (або *in situ*) іммобілізація, яка полягає у безпосередньому формуванні іммобілізованого полімерного шару на поверхні неорганічного носія. Особливо цей спосіб іммобілізації полімеру на неорганічній поверхні є цінним при роботі з кополімерами, оскільки дозволяє створити на поверхні неорганічного носія полімерний прошарок з оптимальним співвідношенням складових кополімеру.

Нами показано, що *in situ* іммобілізація кополімеру 4-вінілпіридину та стирену (у співвідношенні 4:1) на поверхні силікагелю призводить до сорбційної активності синтезованого матеріалу щодо мікрокількостей іонів Pb(II), Mn(II), Fe(III) та Ni(II) у нейтральному водному середовищі.

Дана робота присвячена *in situ* іммобілізації поверхні сапоніту Ташківського родовища кополімером 4-вінілпіридину та стирену (у співвідношенні 4: 1) та дослідженню сорбційних властивостей синтезованого матеріалу щодо іонів Pb(II), Cd(II), Cu(II), Mn(II) Zn(II) та Fe(III). Результати роботи засвідчують, що модифікація поверхні сапоніту даним кополімером підвищує його сорбційну ємність у нейтральному водному середовищі щодо іонів Pb(II), Mn(II) та Fe(III).

## Design and study of a laser system for detecting optical devices

O.S. Hnatenko<sup>1,2</sup>, Yu.P.Machekhin<sup>1,2</sup>, M.V. Neofitnyi<sup>2</sup>, S.V.Gulak<sup>3</sup>

<sup>1</sup>Physical Foundations of Electronic Engineering Department,

<sup>2</sup>Kharkiv National University of Radio Electronics

Nauky Ave.14, 61166

Kharkiv, Ukraine

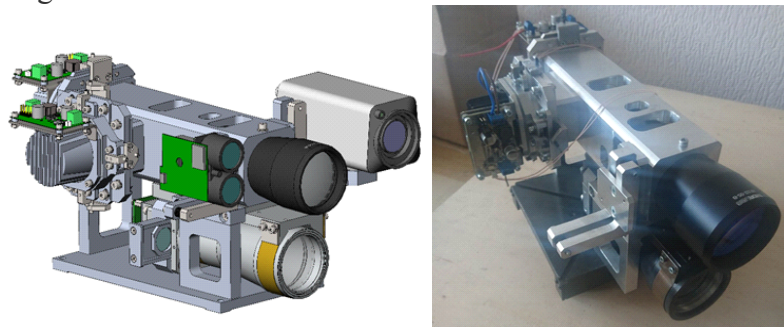
<sup>3</sup>PJS NII Laser Technology PJSC

Kharkiv, Ukraine

Email of corresponding author: oleksandr.hnatenko@nure.ua

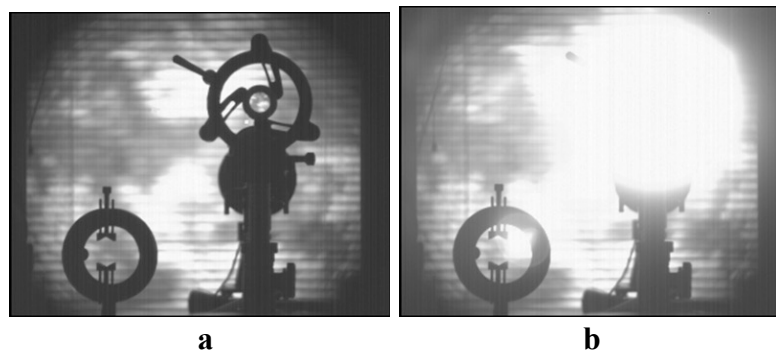
The development of a laser system for detecting optical devices is presented in this research work. The proposed laser system is based on two principles: first, fixing glare from optical devices;

second, fixation with the help of a high-sensitive photodiode of low-intensity emission, which in turn complicates the operation of counteraction systems offered for the laser system. Laser system showed in Figure 1.



**Figure 1 – Laser system for detecting optical devices**

Laser system consist of two optical radiations 808 and 940 nm. From the studies, it can be concluded that a laser with a wavelength of 940 nm gives a significantly higher reflection coefficient. It is also confirmed that the presence of a light filter in the system under study does not coincide in wavelength with laser radiation significantly improves the ability to detect optical objects, Figure 2 b.



**Figure 2 – The study of the health of the laser system: (a) The investigated object (lens); (b) Reflection from the radiation object with a wavelength of 940 nm**

## Optimization of Transport Mobile Communication Network

Hvostyk IHOR<sup>1</sup>, Lubov TOKAR<sup>2</sup>, Yana KRASNOZHENIUK<sup>3</sup>,  
Al-Vandavi Saif Ahmed ISKANDAR<sup>4</sup>

V.V. Popovskyy Department of Infocommunication Engineering,  
Kharkiv National University of Radio Electronics  
Nauky Ave. 14, Kharkiv, Ukraine  
Kharkiv  
Ukraine

[ihor.khvostyk@nure.ua](mailto:ihor.khvostyk@nure.ua), [yana.krasnozheniuk@nure.ua](mailto:yana.krasnozheniuk@nure.ua), [liubov.tokar@nure.ua](mailto:liubov.tokar@nure.ua)

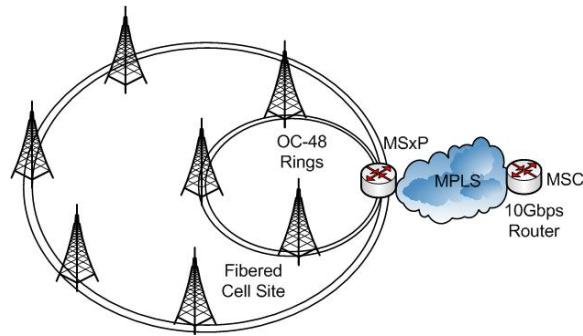
### Abstract

The mechanism of Ethernet signal transmission over the air is considered. The advantage of this transmission method is the minimum delay with high-performance backhaul. It is shown that monitoring delay using brute-force methods at the port or software level does not reveal delay problems affecting certain traffic classes. For deep performance delays, it is necessary to take measurements that cover the full service path at the demarcation points and at the key nodes between them.

Ethernet mobile services and implementation of mobile systems based on packet data transmission will provide mobile operators with scalable and more economical solutions for processing both the growing number of mobile devices connected to their networks and the volume of traffic.

One of the main reasons for the wider use of Carrier Ethernet in backhaul wireless applications is the ability to use a variety of physical infrastructures to deliver Carrier Ethernet to a base station. One of the physical mechanisms of signal transmission is Ethernet over a radio channel, which is characterized by a minimum delay and a reliable, high-performance backhaul for 3G and 4G wireless networks. It is known, however, that real-time data transfer, transactional applications, high-speed roaming and multimedia streaming are sensitive to delays. Increasing the delay by only a few milliseconds can lead to voice distortion, disruption of the application, which will affect significant losses of operators.

Although Ethernet offers easy access to bandwidth on demand, the bandwidth of the dialing service often has little effect on delay if the link was originally correctly defined. Let us consider a cellular communication BS connected to an access platform using an optical communication line 100FX, with a CIR (fixed information transmission rate, forcibly limiting rate) of 20 Mbit/s (Fig. 1). If the BS traffic never exceeds 20 Mbit/s, then increasing the throughput to 30, 50 or even 100 Mbit/s will not affect the delay. Although the capacity can be increased, each packet is still tied to the physical communication speed agreed between the ports (for example, 100 Mbit/s for 100FX media) [1]. This means that the delay is the same as long as the physical connection remains the same.



**Figure 1.** Network architecture of transport network

As bandwidth increases, data loads faster, but each individual packet still moves at the same rate. Instead of increasing CIR, applications should connect at a faster rate to reduce delay, for example, changing from 100FX to the GbE interface would reduce delay by a factor of ten. In many cases, this requires replacement or modernization of network equipment, which is an expensive and time-consuming solution.

Under the overload, an increase in bandwidth will reduce the delay, but only if the bandwidth increases from end to end. For example, if Ethernet-over-SONET/SDH (EoS) is used for transport, increasing the last mile carrier will have little effect on overall delay if packets are still transported through the same TDM “container” (for example, DS3/E3). This is similar to the Ethernet data rate effect: the rate of traffic entering the network does not affect the delay if the TDM/core preparation remains unchanged.

Similarly, in all packet networks (for example, MPLS core), if the end-to-end network does not have sufficient capacity, the packets will be overloaded in the core instead of the access network, simply pushing out the problem elsewhere. When this happens, an increase in access bandwidth can lead to even longer delays, since already occupied NES cores add more traffic to their queues and load processing [2].

The reasons for the delay are complex and non-deterministic. To maintain overall QoS, delay and jitter should be constantly monitored based on each service, application, SLA or VLAN. Monitoring of delay using brute-force methods at the port level or software (for example, ping) does not reveal delay problems that affect certain classes of traffic, and cannot isolate whether a delay occurs at the IP or Ethernet level (Fig. 2).

## **Decision making in information technologies for analysis of scientific and applied problems**

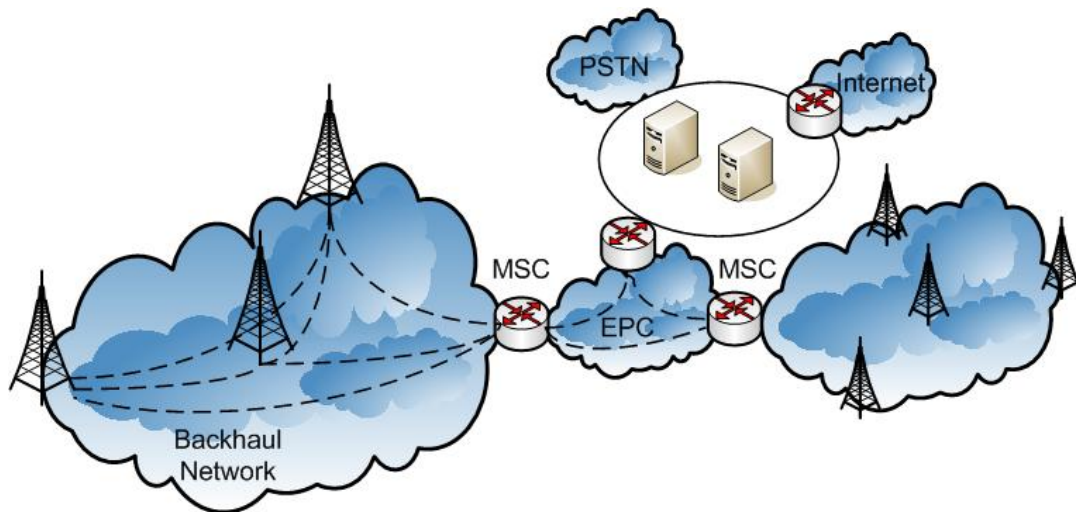
Prof. Dr. Igor Grebennik, Chair of Systems Engineering Dept., Computer Science Faculty, Kharkiv National University of Radio Electronics.

Information technologies in modern society apply in all possible areas, in particular when solving scientific and applied problems. One of the most important components of any information technology is decision making. Whenever decision-makers need to choose one of the possible alternatives, subject to certain conditions, they use the methods of decision theory. Being an independent research and applied area, decision theory offers tools for the development and implementation of information technology.

The purpose of the work is to review the main provisions of decision-making as a component of information technologies used in different spheres. Decision-making is based on a system analysis of objects and processes and can be used to study various scientific and applied problems. The formal description and main classes of decision-making problems are considered. Their use in the creation and implementation of information technologies for analysis of scientific and applied problems is discussed. The features of classes of decision-making problems and corresponding methods for their solution are demonstrated. Essential examples are given.

**Keywords:** decision making, information technology, alternative, optimality principle, multifactorial estimation.





**Figure 2.** Monitoring of transport routes

Likewise, end-to-end delay monitoring is not sufficient for SLA reporting and troubleshooting of delay problems in networks where traffic is often asymmetric, therefore one-way delay and jitter measurements are required. In order to provide a complete picture of the delay performance, measurements should also cover the complete service path, from end to end (demarcation point and at key nodes between them). This allows the operator to isolate delay problems for access, core networks or, more importantly, customer networks.

Delay measurements require sufficient accuracy to detect minor delay changes to proactively determine delay drift, which can lead to QoS problems and SLA violations. Accuracy must be at least one order of magnitude greater than the target threshold in order to be useful (for example, submilliseconds if the SLA determines the maximum delay of 10 ms). Otherwise a measurement error will mask the delay problem, generate false alerts, or even result in to negative delays in client SLA reports.

Similarly, measurements require sufficient details to detect short-term delay problems that may indicate micro-bursts, inefficient traffic management methods, or improperly configured NEs. The ability to measure every second, for example, provides enough information to diagnose intermittent QoS problems.

Thus, to ensure that delay problems are fully visible, measurements should:

- be held for each flow, application, service or VLAN;
- the delay should be measured from end to end to accurately take into account all segments of the network, as well as key intermediate nodes, to isolate problems;
- have a high degree of detail.

Therefore, to reduce the delay with the increase in bandwidth, it is important to determine if there is an overload in a service segment. Since providing additional bandwidth is time consuming and expensive from the point of view of the network, it is better to increase it where it will increase productivity the most.

#### References:

- [1]. Н.Н. Васин. *Системы и сети пакетной коммутации/Самара: ФГОБУ ВПО ПГУТИ. 2012, 283.*
- [2]. B. Saranya, S. Muruganandham. *Mobile Backhaul Network in wireless Sensor // International Journal of Engineering Research and General Science. 2015, vol. 3., 394 – 397.*

## Microcirculation Evaluation Capabilities Using Capillaroscopy

Kovalova Anastasiia

Computer Science and Technology, Biomedical Science

St . Saltivske highway, 65B, 4

Kharkiv

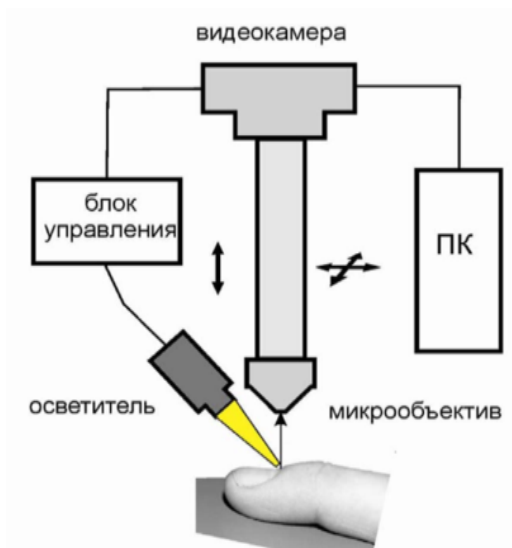
Ukraine

Email of corresponding author: anastasiia.kovalova@nure.ua

An urgent issue of modern medicine is the search for new diagnostic methods to detect the smallest changes even at the preclinical stage [1, 2]. The study of the microcirculation system for surgery planning [3, 4] is very important for the diagnosis, assessment of the severity and nature of the course of pathological processes in the human body, predicting their dynamics, and monitoring the effectiveness of treatment [4, 5]. Biomicroscopic methods for studying capillary blood flow are traditionally used to study microcirculation and others parameters on microlevel [6, 7]. The main advantage of these methods is the ability to evaluate indicators such as the diameter of the microvessel [8], the passage of blood through them, the state of aggregation of the blood, the density of the capillaries, which is impossible with any other non-invasive technique. One of the most relevant and promising methods is capillaroscopy [9, 10].

The aim of the study is to study the possibilities of capillaroscopy in clinical practice as an informative and accessible method for assessing the state of peripheral blood circulation, as well as to study the mechanism of operation of an optical and computer capillaroscope.

**Figure. Scheme of the structure of a computer capillaroscope**



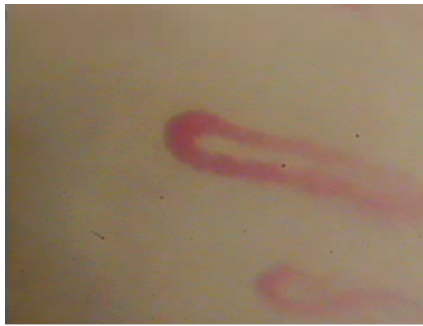
The essence of metabolic processes in the body is the constant redistribution of substances between the blood capillary, surrounding tissue and lymphatic capillaries. So, for an adequate description of metabolic processes, assessment of the functional reserves of the body,

identification of early forms of diseases and prediction of the reliability of examination, it is necessary to study the basic physiological functions of metabolism at the level of the microvasculature.

Since capillary circulation carries out the main function of the microcirculatory system - transcapillary metabolism, i.e., metabolism between blood and tissues, the state of microcirculation can serve as an arbiter of the well-being of systemic hemodynamics and the display of preserved arteriovenous equilibrium in regional vascular pools.

Given the fact that the change in the capillary link is closely correlated with shifts in central hemodynamics, it becomes possible to use microcirculation parameters as prognostic and diagnostic criteria for assessing the overall physical health of the subjects. Therefore, the work considered a qualitative and quantitative analysis of capillaries. This analysis is the main part of pathomorphological studies of microcirculation. A classification of microcirculatory disorders based on quantitative characteristics was also developed that was specially developed to form a medical report on the severity of microcirculation disorders, which indicates the state of the body as a whole, and normal indicators are considered.

**Figure. Normal capillary image**



In the process, we gradually came to the following classification with goal of a more complete clinical interpretation of changes capillaroscopic picture. Some of them: the shape of the capillary, the length of the capillary, the characteristic of the capillary in caliber, the specific gravity of the capillaries, the level of blood supply, the speed of capillary blood flow, the background of the capillary field, etc. All these indicators can help recreate the picture of the patient's health status and identify pathological disorders in his body.

The research helped to establish that the study of microcirculation using a method such as capillaroscopy can reveal the initial morphological and functional changes in the development of a number of diseases, as well as to monitor the effectiveness of treatment. The advantages of capillaroscopy are its uniqueness, painlessness, non-invasiveness, observation of microcirculation in the "natural environment", which increases the accuracy of diagnosis. The identification of the preclinical stages of various diseases opens up completely new opportunities for their prevention, and the monitoring of prescribed therapy makes it possible to conduct optimal treatment individually for each patient. The development of computer processing techniques for the obtained capillaroscopic images will allow the formation of an algorithm for the qualitative and quantitative analysis of the level of microcirculation, which will further improve the quality of objectification of the detected violations. Also, the fact of monitor visualization of a disturbed level of

microcirculation is often a factor for the patient to increase confidence in the doctor, the conscious need for treatment to eliminate the detected violations.

Regular capillaroscopy allows you to diagnose microcirculatory disorders, non-invasively monitor the effectiveness of therapy in almost all patients, and also monitor the status of patients associated with high-risk factors during professional examinations.

So, method of capillaroscopy is one of the most promising diagnostic methods at this stage in the development of medicine for complex diagnostic and treatment planning.

## References

- [1] Oleg G. Avrunin, Natalia O. Shushlyapina, Yana V. Nosova, Wojciech Surtel, Aron Burlibay, Maral Zhassandykyzy. Method of expression of certain bacterial microflora mucosa olfactory area. Proc. SPIE 9816, Optical Fibers and Their Applications, 2015, 98161L (December 18, 2015), doi:10.1117/12.2229074.
- [2] Avrunin O.G., Nosova Y.V., Shuhlyapina N.O., Zlepko S.M., Tymchyk S.V., Hotra O., Imanbek B., Kalizhanova A., Mussabekova A., Principles of computer planning in the functional nasal surgery. *Przegląd Elektrotechniczny* 93(3)/2017, 140-143.
- [3] Oleg G Avrunin, Yana V Nosova, Victor G Paliy, Natalia O Shushlyapina, Maksat Kalimoldayev, Paweł Komada, Azhan Sagymbekova. Study of the air flow mode in the nasal cavity during a forced breath. *Proceedings Volume 10445, Photonics Applications in Astronomy, Communications, Industry, and High Energy Physics Experiments 2017*; 104453H (2017); doi: 10.1117/12.2280941
- [4] Skidanov, A., Avrunin, A., Tymkovych, M., Zmiyenko, Y., Levitskaya, L., Mischenko, L., & Radchenko, V. (2015). Assessment of paravertebral soft tissues using computed tomography. *Orthopaedics, traumatology and prosthetics*, 3, 61-64. doi:10.15674/0030- 59872015361-64
- [5] Nosova, Ya. V. Biotechnical system for integrated olfactometry diagnostics / Ya. V. Nosova, O. G. Avrunin, V. V. Semenets // *Innovative technologies and scientific solutions for industries*. – 2017. – No. 1 (1). – P.6 4 – 68. – doi:10.30837/2522-9818.2017.1.064
- [6] Носова, Я. В. Определение микрохарактеристик воздушного потока в носовой полости при дыхании / Я. В. Носова, О. Г. Аврунин, Х. И. Фарук // *Вестник НТУ «ХПИ», Серия: Новые решения в современных технологиях*. – Харьков: НТУ «ХПИ». – 2018. – № 16 (1292). – С. 122-127. – doi:10.20998/2413-4295.2018.16.19.
- [7] Носова, Я. В. Разработка метода экспресс диагностики бактериальной микрофлоры полости носа / Я. В. Носова, Х. Фарук, О. Г. Аврунин // *Проблеми інформаційних технологій*. – Херсон, 2013. – № 13. – С. 99-104.
- [8] Hardware-software complex for studying the effect of air composition on the aerodynamic parameters of nasal breathing / O. Avrunin, Ya. Nosova, N. Shushliapina, S. Khudaieva, Ibrahim Younouss Abdelhamid. // *Proceedings of the XV International Scientific and Practical Conference "International Trends in Science and Technology"*, Warsaw, Poland. – Vol.1, 2019. – P. 17-20.
- [9] Lutchik U. B. Modern opportunities of capillaroscopy. - 2004, p. 36-38
- [10] Shchabrykina N. S. The use of a mathematical model of microcirculatory processes for the diagnosis of functional disorders of microcirculation. – 2007, 9–14

# ЭЛЕКТРОМАГНИТНАЯ РЕШЕТОЧНАЯ «НЕВИДИМОСТЬ» ФОТОННОГО КРИСТАЛЛА ИЗ МАГНИТОДИЭЛЕКТРИЧЕСКИХ СФЕР В ФОРМЕ ОКТАЭДРА

Козарь А.И.

Кафедра физики, Харьковский национальный университет радиоэлектроники  
просп. Науки, 14, Харьков, Украина  
E-mail of corresponding author: d\_ph@nure.ua

Аннотация – представлены решения и анализ задачи о явлении электромагнитной решетчатой «невидимости» резонансного ограниченного кристалла из сфер в форме октаэдра с кубической кристаллической решеткой.

Проблема моделирования явления «невидимости» физических тел в оптическом и рентгеновском диапазонах длин волн является серьезным направлением исследований в прикладной электродинамике. В предлагаемом сообщении анализируются свойства ограниченного метакристалла в форме октаэдра с кубической решеткой, когда в нем возбужден структурный (решеточный) резонанс, при котором возникает явление электромагнитной решеточной «невидимости».

Здесь рассматривается случай эквивалентный рентгеновской оптике кристаллов, когда  $a/\lambda' = 1$ ;  $a/\lambda_g = 1$ ,  $d, h, l/\lambda' = 1$ ; где  $a$  – радиус сфер;  $\lambda', \lambda_g$  – длины рассеиваемой волны вне и внутри сфер,  $d, h, l$  – постоянные решетки. Решение задачи получено на основе интегральных уравнений электродинамики Фредгольма 2-го рода [1, 2, 3].

## References

- [1] Kozar A.I. J. Telecommunication and Radio Engineering. New York (USA): Begell House Inc. 2004, Vol. 61, No.9, 734-749.
- [2] Anatoliy I. Kozar. International Journal of Electromagnetics and Applications. 2013, Vol. 3, No.2, 15-19.
- [3] A.I. Kozar. Monograph. Ukraine, Kharkiv: KNURE, 2014, 352 p. (in Russian).

## **Dynamical Fractal Analysis of the Acoustic Ultra-Wideband Signal Caused by the Chelyabinsk Meteoroid**

Andriy A. Onishchenko, Leonid F. Chernogor, Oleg V. Lazorenko\*

Physics Department, Kharkiv National University of Radioelectronics  
14, Nauka Avenue  
Kharkiv, Kharkiv Region  
Ukraine  
Oleg.V.Lazorenko@karazin.ua

The non-linear paradigm claims, that many processes in open, non-linear, dynamical systems, which caused by the non-stationary, powerful sources, are appeared to be short-time, non-linear, ultra-wideband and fractal ones [1 – 3]. The acoustic signals created by the Chelyabinsk meteoroid fall were shown to be namely ones of them [4, 5]. Using a new fractal analysis method called as ‘Dynamical Fractal Analysis’, the fractal properties of these signals were investigated. The corresponding numerical characteristics were estimated and discussed.

### **References**

- [1] L. F. Chernogor, About Nonlinearity in Nature and Science: Monograph, Kharkov: V. N. Karazin Kharkov National University, 2008 (in Russian).
- [2] L. F. Chernogor, V. T. Rozumenko, *Radio Phys. and Radio Astron.* **2008**, 13, 2, 120 – 137.
- [3] L. F. Chernogor, *Space Science and Technology.* **2003**, 9, 5/6, 96-105 (in Russian).
- [4] L. F. Chernogor, O. V. Lazorenko. *Proc. 8th Int. Conf. on Ultrawideband and Ultrashort Impulse Signals*, **2016**.
- [5] O. V. Lazorenko, L. F. Chernogor. *Radioelectr. and Comm. Sys.* **2017**, 60, 8, 331–338.

## Study of FTIR, BET and H<sub>2</sub> Adsorption Properties of Natural and Ion-Exchanged Sepiolite

Meryem Akbelen<sup>1,\*</sup>

<sup>1</sup>Department of Physics, Faculty of Science, Eskişehir Technical University, 26470, Eskişehir, Turkey

\*Corresponding author: msakizci@eskisehir.edu.tr

In this study, the hydrogen adsorption on natural sepiolite, Turkey and that of Cu-, Fe-ve H-exchanged forms were investigated at 77 K up to 100 kPa. Sepiolite (Si<sub>12</sub>O<sub>30</sub>Mg<sub>8</sub>(OH)<sub>4</sub>(H<sub>2</sub>O)<sub>4</sub>.8H<sub>2</sub>O) is a natural hydrated magnesium-silicate type clay mineral with fine microporous channels of molecular dimensions 3.7 Å × 10.6 Å running along the fiber axis. Sepiolites have many industrial and environmental applications. Clay sample from Eskişehir sieved to pass through a < 45 µm sieve. Ion exchange was carried out 100 ml and 1 M of Cu(NO<sub>3</sub>)<sub>2</sub>.3H<sub>2</sub>O, Fe(NO<sub>3</sub>)<sub>3</sub>.9H<sub>2</sub>O and HCl solutions at 80 °C during 6 h using batch method. Then, the cation exchanged samples were filtered, washed with hot distilled water several times, dried in an oven at 110 °C for 16 h and stored in a desiccator. Fourier transform infrared spectroscopy (FTIR) absorption spectra of sepiolite samples were recorded using Perkin Elmer Spectrum Two model spectrophotometer with KBr pellet technique at 4cm<sup>-1</sup> resolution in transmittance mode from 4000 to 400 cm<sup>-1</sup>. Brunauer – Emmett – Teller (BET) equation was used to determine the surface area of the samples. The *t*-plot method was applied to obtain the micropore surface area and volume. For sepiolite clay, the adsorption capacities of hydrogen decreased in the order HS > FeS > S > CuS.

**Keywords:** Adsorption; Hydrogen; Sepiolite; B.E.T.; FTIR.

## Hydrogen Adsorption Capacities of Natural and Salt Treated Zeolite

Meryem Akbelen<sup>1,\*</sup>, Çağatay Ezber<sup>2</sup>

<sup>1</sup>Department of Physics, Faculty of Science, Eskişehir Technical University, 26470, Eskişehir, Turkey

<sup>2</sup>Graduate School of Science, Eskişehir Technical University, 26470, Eskişehir, Turkey

\*Corresponding author: msakizci@eskisehir.edu.tr

In this study, the hydrogen adsorption isotherms of clinoptilolite-mordenite-rich tuff supplied from Turkey and their exchanged forms ( $K^+$ ,  $Na^+$  and  $Ca^{2+}$ ) were obtained at pressures up to 100 kPa and 77 K. Zeolites are porous, crystalline, hydrated aluminosilicates with the framework structure consisting of  $AlO_4$  and  $SiO_4$  tetrahedra. These are linked to each other by sharing all of the oxygens to form the zeolite structure containing channels. Hydrogen is the simplest and most abundant element in nature; it will probably be the most significant energy source in the future if it is stored more economically and safely. Zeolite samples were ground and sieved to obtain  $< 45 \mu m$  fractions. These zeolite fractions were exchanged with  $K^+$ ,  $Na^+$  and  $Ca^{2+}$  to determine the influence of the exchangeable cation on their hydrogen sorption behavior. The chemical composition of natural and salt-treated zeolite samples was obtained from the powder samples that were fused with lithium tetraborate using an XRF device, Rigaku ZSX Primus. Powder XRD patterns were recorded on powdered samples with a Rigaku RINT-2200 diffractometer using  $Cu K\alpha$  radiation and operated in the  $2\theta$  range between  $3^\circ$  and  $70^\circ$ , with a step size of  $0.02^\circ$ .  $H_2$  adsorption capacities of all samples were obtained by Quantachrome Autosorb-1C gas adsorption analyzer.

**Keywords:** Natural zeolite; Hydrogen; Clinoptilolite; Mordenite; XRF; XRD.



## Investigation of thermal and structural properties of nitric, hydrochloric and sulphuric acid-treated zeolite

Çağatay Ezber<sup>1</sup>, Meryem Akbelen<sup>2,\*</sup>

<sup>1</sup>Graduate School of Science, Eskişehir Technical University, 26470, Eskişehir, Turkey

<sup>2</sup>Department of Physics, Faculty of Science, Eskişehir Technical University, 26470, Eskişehir, Turkey

\*Corresponding author: msakizci@eskisehir.edu.tr

In this study, in order to consider the effect of the nitric, hydrochloric and sulphuric acid treatment on thermal and structural properties, zeolite was modified with 1 M acid solutions at 70 °C during 4 h using batch method. Zeolites consist of three-dimensional network of connected SiO<sub>4</sub> and AlO<sub>4</sub> tetrahedra by sharing common oxygen atoms. The presence of exchangeable cations (Na<sup>+</sup>, K<sup>+</sup>, Ca<sup>+2</sup> etc.) allows for modification of characteristic properties. Zeolite sample from Sivas-Yavu region of Turkey was ground to less than 45 µm. Chemical compositions were determined on powdered samples fused with lithium tetraborate using X-ray fluorescence analysis (XRF – Rigaku ZSX Primus instrument). The XRD diffractograms were obtained with a Rigaku, RINT-2200 model instrument, using CuK $\alpha$  radiation ( $\lambda=1.54$  Å), 40 kV and 30 mA power supply over the scan range of  $2\theta = 3$  to  $70^\circ$  with an incremental step size of  $0.02^\circ$ . XRD analysis showed that the major components of the natural zeolite were clinoptilolite and mordenite, together with minor amounts of quartz, feldspar and clay mineral. The TGA-DTG-DTA (Thermogravimetric–Differential Thermogravimetric-Differential Thermal Analysis) measurements were performed with Setsys Evolution Setaram equipment using a rate of  $10^\circ\text{C}/\text{min}$  from  $30^\circ\text{C}$  to  $1000^\circ\text{C}$ .

**Keywords:** Natural zeolite; Clinoptilolite; Mordenite; XRD; TGA-DTG-DTA; XRF.

# ADOPTION OF CLOUD COMPUTING IN HIGHER EDUCATION SECTOR: AN OVERVIEW

**Mohammad AL RAWAJBEH<sup>1,\*</sup>, Issam ALHADID<sup>2</sup>, Hssan AL-ZOUBI<sup>3</sup>**

<sup>1</sup> Department of Computer Science, Faculty of Science and Information Technology, Al Zaytoonah University of Jordan, Amman, Jordan

<sup>2</sup> Department of Business Information Technology, University of Jordan/Aqaba, Jordan.

<sup>3</sup> Department of Mathematics, Faculty of Science and Information Technology, Al Zaytoonah University of Jordan, Amman, Jordan

## ABSTRACT

Cloud computing started playing an effective role in enhancements the quality of education in higher institutions. This technology provides many internet based valuable services without need for owning additional equipment or installing new software with minimum cost. This research aims to highlight the main challenges and concerns of using CC, not only focusing on the benefits. The research presents a systematic review of CC concept, models, services and there positive effect and significant impact on higher education institutions. The result of conducted analysis found that there are many challenges and concern which have to be overcome before deciding adopt the CC in Higher education environment. Transition to CC model must be done according to a comprehensive plan which handle the different sources of challenges. Concerns and challenges are classified into categories and each subcategory is discussed. The guidelines and recommendations which offered by this research can lead to overcome many challenges and clarify the roadmap of successful adoption of CC in high education institutions.

**Keywords:** Cloud computing, higher education, adoption of cloud computing, cloud technology, service model.

# СПОСОБЫ РАСШИРЕНИЯ РАБОЧЕЙ ПОЛОСЫ ЧАСТОТ ДЛЯ МНОГОЗОНДОВОЙ ИЗМЕРИТЕЛЬНОЙ ЛИНИИ СВЧ

Мирошник М.А. , Зайченко О.Б.

*Украинский университет железнодорожного транспорта,  
Харьковский национальный университет радиоэлектроники, г.Харьков*

Развитие различных направлений науки и техники, связанных с использованием радиосигналов, характеризуется освоением все более высоких частот электромагнитных колебаний. Последние десятилетия ознаменовались бурным освоением СВЧ диапазона и соответственно развитием измерительной техники для этого диапазона, представителем которой техники является многозондовая измерительная линия, представляющая собой отрезок линии передачи с датчиками, сигналы которых обрабатываются с помощью вычислительных устройств по алгоритмам, записанным в контроллер измерителя. С целью расширения диапазона частот строят математическую модель многозондовой измерительной линии (МИЛ) и проводят ее анализ. Модель представляет собой систему линейных уравнений. Для решения системы уравнений используют аппарат линейной алгебры – вводят промежуточные переменные, описывающие постоянную и переменную составляющие кривой стоячей волны в тракте. Количество датчиков и способ их размещения определяется из математической модели, используя в качестве критерия оптимальности минимум погрешности оценки мощности и комплексного коэффициента отражения (ККО). Если количество датчиков больше, чем число переменных, то повысить точность можно за счет усреднения и компенсации случайных погрешностей. В таком случае используется в качестве алгоритма обработки сигналов датчиков метод наименьших квадратов (МНК). А для анализа погрешностей можно использовать прикладной линейный регрессионный анализ. В D-оптимальном планировании эксперимента, которое выбрано для анализа, минимизируется объем эллипсоида рассеяния, то есть погрешность. Аналитической записи эллипсоида рассеяния соответствует матрица дисперсий и ковариаций, для вычисления которой на основании матрицы системы уравнений в предположении многомерного нормального распределения погрешностей сигналов датчиков и руководствуясь принципом максимального правдоподобия, строится информационная матрица Фишера, которая затем инвертируется. При этом изменение частот заложено в матрице системы уравнений через фазовое расстояние между соседними датчиками. Таким образом, варьируя фазовое расстояние или обратную ему величину пропорциональную длине волны, находят зависимость погрешности от диапазона частот. Проведенное моделирование для количества датчиков равного четыре, шесть и восемь показало уменьшение погрешности с ростом числа датчиков. Так для четырех датчиков рабочий диапазон составляет менее октавы. Для шести датчиков превышает октаву. А для восьми датчиков отношение максимальной длины волны к минимальной более пяти, то есть две октавы.

# The Change of Line Ratio of Optical Emission Spectra with Time for Inductive Radio Frequency Argon Discharge at Low Pressure

Murat Tanışlı\*

Department of Physics, Faculty of Science, Eskişehir Technical University  
Yunus Emre Campus  
Eskişehir  
Turkey

Email of corresponding author: mtanisli@eskisehir.edu.tr

Plasma in the non-local thermodynamic equilibrium (non-LTE) can be produced with inductively radio-frequency discharges at low pressure [1]. Non-LTE plasmas are used in industries in manufactory process, biomedical coating and plasma-enhanced chemical vapour deposition. The effects of cold plasma on microorganism have also been investigated as discharge or afterglow downstream discharge application [2-6]. Therefore, some characteristic parameters of inductive radio frequency (RF) argon (Ar) discharge and afterglow downstream discharge at low pressure were investigated with optical emission spectroscopy (OES) in this study. The wavelengths of spectral lines from OES were obtained between 650-900 nm. For all measurements, a spectrum line that remained at approximately the same value was taken as the value of the reference wavelength throughout the study. The changes in the optical emission spectrum line ratios of the inductive RF Ar discharge and the afterglow downstream discharge with respect to time were compared. As a result, it was reported that some transitions for both regions were to be increased in time. The transitions in time for some wavelengths (738.76, 751.69, 772.59, 801.84, 810.68 and 842.85 nm) have been approximately improved between 20% and 34% for discharge zone. Also, it can be increased for wavelength 801.84 nm in afterglow downstream discharge region (32.55%).

## References

- [1] A. Bogaerts, E. Neyts, R. Gijbels and J. van der Mullen *Spectrochimica Acta Part B* **2002**, 57, 609–658.
- [2] I. Tanarro, V.J. Herrero, E. Carrasco and M. Jiménez-Redondo *Vacuum* **2011**, 85, 1120-1124.
- [3] A. Friedman *Plasma Chemistry* **2008**, Cambridge: Cambridge University Press.
- [4] A.D. Morris, G.B. McCombs, T. Akan, W. Hynes, M. Laroussi and S.L. Tolle *Journal of Dental Hygiene* **2009**, 83 (2), 55-61.
- [5] T. Okumura *Physics Research International* **2010**, Volume 2010, Article ID 164249 (14pp).
- [6] G. Petitpas, J.D. Rollier, A. Darmin, J. Gonzalez- Aguilar, R. Metkeneijer and J.D. Fulcheri *International Journal of Hydrogen Energy* **2007**, 32, 2848-2867.

# Investigation of Argon Plasma Jets with Spectral Line Intensity Ratio

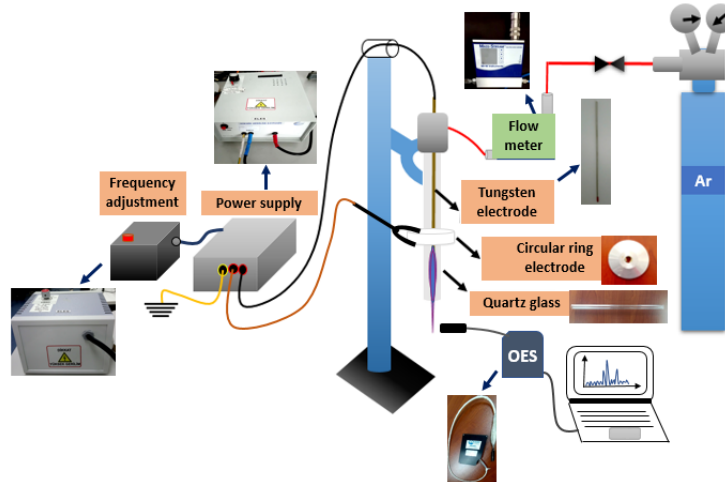
Murat Tanışlı<sup>1,\*</sup>, Sevinç Yanık<sup>1</sup>, Neslihan Şahin<sup>1</sup>

<sup>1</sup>Department of Physics, Faculty of Science, Eskişehir Technical University  
Yunus Emre Campus  
Eskişehir  
Turkey

\*Email of corresponding author: mtanisli@eskisehir.edu.tr

At the atmospheric pressure, argon plasma jet was obtained for 20 kHz frequency, 8 kV voltage and different flow rate in the DBD-like system as seen figure. The optical emission spectra of these jets were taken. Spectral lines of discharges experimentally obtained were compared with spectral lines in NIST (National Institute of Standards and Technology) database. Atmospheric pressure plasmas are optically thin [1]. Therefore, the line intensity ratio method can be used by determining suitable spectral lines. In general, the intensity of a spectral line is a function of both electron temperature and density [2]. The spectral lines, which are sensitive to electron temperature, were selected to use this method. These spectral lines depend on the difference between the excitation energy levels and the transition probability ratios [3]. As a result, the electron temperature of argon jet was tried to be determined by line intensity-ratio method.

Figure



## References

- [1] X. M. Zhu, Y. K. Pu, N. Balcon and R. Boswell, *J. Phys. D: Appl. Phys.* **2009**, 42, 142003 (5pp).
- [2] J. Lee, W. Ko, D. Seo, Y. Kim and J. Yoon, *Fusion Science and Technology*. **2009**, 55 (2T), 100-105.
- [3] A. Boogaard, A.Y. Kovalgin, A.I.A. Aarnink, R.A.M. Wolters, J. Holleman, I. Brunets, J., Schmitz, Measurement of electron temperatures of argon plasmas in a high-density inductively-coupled remote plasma system by Langmuir probe and optical-emission spectroscopy, *Proceedings of the 9th annual workshop on Semiconductor Advances for Future Electronics and Sensors*, **2006**, 412-418.

## Analysis of Restrictions Influence in Implementation of Space-Time Access Methods

Mykola MOSKALETS<sup>1</sup>, Oleksiy SAMOYLENKOV<sup>2</sup>, Kyrylo KULISH<sup>3</sup>,  
Kostiantyn SIELIVANOV<sup>4</sup>

V.V. Popovskyy Department of Infocommunication Engineering,  
Kharkiv National University of Radio Electronics  
Nauky Ave. 14, Kharkiv, Ukraine  
Kharkiv  
Ukraine  
mykola.moskalets@nure.ua

**Abstract.** The article analyzes the impact of restrictions on the effectiveness of space-time processing techniques in the antenna array during the implementation of space-time access methods. The method of qualitative and quantitative assessing the impact of the sum of the destabilizing factors in the form of restrictions affecting the signal to interference + noise ratio (SINR) is proposed on the basis of calculating the spatial coherence factor (SCF), which represents the value of the scalar product of the vectors of the desired signal and interference signal space.

The estimation of the upper and lower SINR values has been performed using spatial coherence factor in the assumption that the level of the interference signal interfering an SS at the entrance of AAA is significantly greater than the thermal noise power. The estimate of normalized index SINR reduction has been obtained regarding SCF.

The conditions of the SCF influence on the convergence rate of the adaptation process of the AAA control algorithms are shown and the analysis of the SCF boundary values is carried out, as a result of which the basic approaches to the construction of the AAA have been developed.

### REFERENCES

- [1] Monzingo R. A., Miller T. U. *Adaptivnye antennye reshetki. Vvedenie v teoriyu.* Moscow, 1986. 448 p.
- [2] Balanis K. A., Ioanides P. I. *Vvedenie v smart-antenny.* Moscow, 2012. 200 s.
- [3] Marchuk L.A. *Prostranstvenno-vremennaia obrabotka syhnalov v lyniakh radyosviazhy / L.A. Marchuk.* L., VAS, 1991. 136 s.
- [4] Heng-Cheng Lin. Correction to "Spatial Correlations in Adaptive Arrays". *IEEE Transactions on Antennas and Propagation.* Year: 1982, Volume: 30, Issue: 6 Pages: 1268 - 1268, DOI: 10.1109/TAP.1982.1142929 Referenced in: *IEEE Journals & Magazines* .
- [5] Moskalets, N.V. *Analyz vlyianyia ohranychenyi pry realizatsyy metodov prostranstvenno-vremennoho dostupa. Visnyk natsionalnogo tekhnichnogo univer-sytetu "KhPI".* 2016. №50 (122). S.95–100.

# Characterization of Neon Plasma Jets Generated by Dielectric Barrier Discharge-Like System at Atmospheric Pressure

Neslihan ŞAHİN<sup>1\*</sup>, Murat TANIŞLI<sup>1</sup>

<sup>1</sup>Department of Physics, Faculty of Science, Eskişehir Technical University  
Yunus Emre Campus  
Eskişehir  
Turkey

\*Email of corresponding author: neslihansahin@eskisehir.edu.tr

Alternative current (AC) with kHz frequency, pulsed direct current (DC) and radio-frequency (RF) power supply can be used to produce plasma jet [1]. In this study, neon plasma jets were generated by dielectric barrier discharge-like (DBD-like) system using AC power supply at atmospheric pressure. DBD-like systems have their own advantages. When dielectric is used in the system, more power can easily be transmitted to the plasma applied to conductive materials [2]. Therefore, the optical emission spectroscopy of plasma jets generated with DBD-like system is very important to characterize the plasma jets. The optical emission spectra were recorded to determine the properties of plasma jets with different AC voltages and neon gas flow rates. Emission spectral lines were determined from National Institute of Standards and Technology (NIST) [3]. The spectra of neon plasma jets were analyzed by comparing them with the data obtained from NIST. The results show that intensity of the spectral lines of plasma jets increases with increasing voltage applied to neon gas. In addition, neon plasma jet length was investigated for different conditions. By varying the gas flow rate of neon while the power input and frequency are kept constant, it is observed that the plasma jet length ranges from about 1.0 to 2.2 cm.

## References

- [1] X. Lu, M. Laroussi, V. Puech, *Plasma Sources Sci. Technol.* **2012**, 21, 034005.
- [2] X. Lu, S. Reuter, M. Laroussi, D. Liu, *Nonequilibrium Atmospheric Pressure Plasma Jets: Fundamentals, Diagnostics, and Medical Applications* **2019**, CRC Press, Taylor & Francis Group.
- [3] [https://physics.nist.gov/PhysRefData/ASD/lines\\_form.html](https://physics.nist.gov/PhysRefData/ASD/lines_form.html)

# Theoretical and Experimental Infrared Spectrum Analysis of Cation of Ionic Liquid 1-Ethyl-3-Methylimidazolium

Nihal KUS and Saliha ILICAN

Department of Physics, Eskisehir Technical University, 26470 Eskisehir, Turkey  
nkus@eskisehir.edu.tr

Recently, interest in the field of ionic liquids has burgeoned, producing a wealth of intellectual and technological challenges and opportunities for the production of new chemical and extractive processes, fuel cells and batteries, and new composite materials.

In this study, molecular structure of 1-ethyl-3-methylimidazolium (EMIM) in the case of ionic liquid cation was undertaken at the DFT(B3LYP)/6-311++G(2d,2p) level of approximation using the GAUSSIAN 09 suit of programs. EMIM has two conformers (EMIM-1, EMIM-2) with minimum energies. EMIM-1 and EMIM-2 were found  $C_1$  (double degenerated by-symmetry form) symmetry. Normal coordinate analyses were performed with the BALGA program. Experimental infrared spectra of EMIM were obtained by increasing temperature (room temp. – 150 °C) and compared with calculations. Assignment of the spectra and normal coordinate analyses to characterize the vibrations in EMIM conformers were undertaken. p-electron delocalization through the aromaticity index HOMA (Harmonic Oscillator Measure of Aromaticity) of EMIM calculated using Kruszewski and Krygowski definitions.

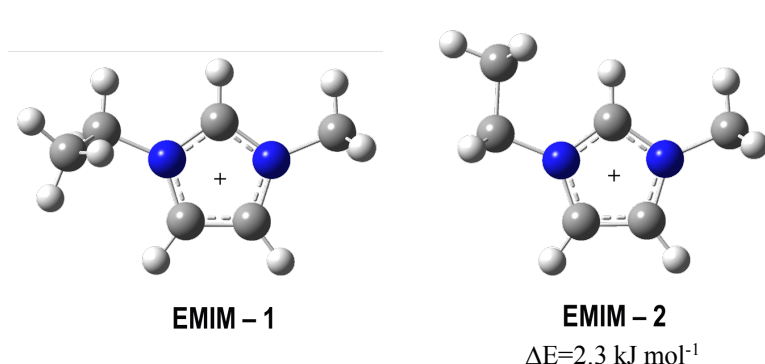


Figure: Cationic EMIM-1 and EMIM-2 conformers calculated by DFT(B3LYP)/6-311++G(2d,2p) level.

**Acknowledgements:** This work was supported by the Eskisehir Technical University Commission of Research Project under grant no: 19ADP130.



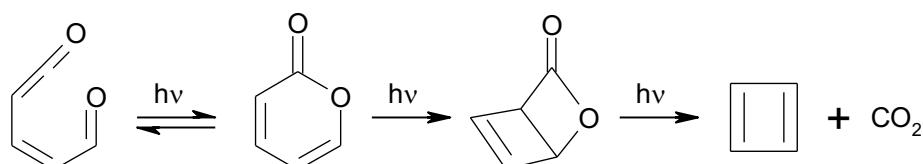
# Photo-Isomerization Reactions of Oxygen Containing Molecules using Matrix Isolation Spectroscopy

Nihal Kuş

Department of Physics, Eskisehir Technical University, 26470 Eskişehir, Turkey

nkus@eskisehir.edu.tr

In this paper, the matrix isolation infrared spectroscopy technique is briefly presented, and its application to the study of photo-isomerization reactions of a set of selected oxygen containing heterocyclic compounds is reviewed. The considered photoreactions included conformational isomerizations as well as bond-breaking/bond-forming structural isomerizations.



**Figure** - Observed  $\alpha$ -pyrone photochemical reaction pathways: fast photoequilibration with the conjugated aldehyde-ketene and slow ring-closure to the Dewar isomer. The Dewar isomer of  $\alpha$ -pyrone subsequently expels  $\text{CO}_2$ , to produce cyclobutadiene [1-4].

## References

- [1] Lin, C.Y., and Krantz, A. 1972, J. Chem. Soc. Chem. Commun., 1111/1112, 1316.
- [2] Chapman, O.L., McIntosh, C.L., and Pacansky, J. 1973, J. Am. Chem. Soc., 95, 244.
- [3] Pong, R.G.S., and Shirk, J.S. 1973, J. Am. Chem. Soc., 95, 248.
- [4] Breda, S., Reva, I., Lapinski, L., and Fausto, R. 2004, Phys. Chem. Chem. Phys., 6, 929.

# **METHOD OF CONGESTION MANAGEMENT AND BALANCED RESOURCE ALLOCATION ON MPLS-TE TELECOMMUNICATION NETWORK ROUTERS**

**Oleksandr LEMESHKO<sup>1,\*</sup>, Tetiana LEBEDENKO<sup>2</sup>**

<sup>1,2</sup> V.V. Popovskyy Department of Infocommunication Engineering, Kharkiv National University of Radio Electronics, Kharkiv, Ukraine

## **ABSTRACT**

The method of congestion management and balanced resource allocation in telecommunication networks operating on the basis of technology of multi-protocol label switching with support of the concept of Traffic Engineering is considered. The essence of the method is the coordinated solution of the problems of aggregation of packet flows and their distribution according to the queues formed on the router interface, as well as the balanced allocation of interface bandwidth in accordance with the principles of Traffic Engineering queues. These technological tasks were reduced to linear programming optimization problems. The proposed method allows increasing the efficiency of distribution and use of network resources while simplifying the computational complexity of the calculations.

**Keywords:** Traffic Engineering, Congestion Management, Resource Allocation, bandwidth balancing, Quality of Service

# DEVELOPMENT OF AN AUTOMATED SYSTEM FOR VIDEO DERMATOSCOPY

st. Olga Isaeva; Doc. of Sc., Professor Oleg Avrunin

Kharkov National University of Radio Electronics  
Kharkiv, Ukraine

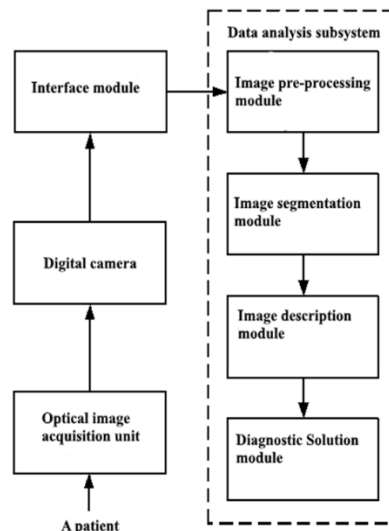
Email: [olgaisaeva399@gmail.com](mailto:olgaisaeva399@gmail.com)

**Introduction.** The work is devoted to the development of an automated system for video dermatoscopy - a method that allows a visual assessment of the condition of the skin and the color and geometric characteristics of the skin formation to determine its nature and the risk of degeneration into a malignant form. Modern research methods require fast and reliable analysis of digitized video information [1, 2].

**The aim of the work** is to develop a complete digital video dermatoscopy system, justification for the use of basic modules and methodological support.

The results of the study. Based on the range of tasks to be solved, the modern digital dermatoscopy system includes:

- a digital optical image acquisition unit with a lens optical system and a digital camera;
- an interface module, including hardware and software for transmitting information to the data analysis subsystem;
- an image pre-processing module for correcting brightness and contrast and suppressing noise components in the image;
- image segmentation - the construction of the characteristic function of the image, highlighting the homogeneous region of objects and background;
- image descriptions - obtaining geometric and optical characteristics segmented in the previous module of objects.
- the formation of a preliminary diagnostic solution in which the analysis of the obtained characteristic features of the image is performed taking into account a priori and additional diagnostic information about the patient.



**Figure 1. - The system of digital video dermatoscopy**

**Findings.** In the tasks of automated processing of video dermatoscopic data, the perception of the field of view is associated with a priori information about the image under study. The main indicators of the effectiveness of the developed methods and systems are high stability and repeatability of recognition of skin objects and the ability to process images in real time. The prospect of work is the development of a complete system for digital video dermatoscopy and its subsequent preliminary clinical trials.

## **Bibliography.**

1. Nosova Ya. V. Development of a method for rapid diagnosis of bacterial microflora of the nasal cavity / Ya.V. Nosova, H.I. Faruk, O.G. Avrunin // Problems of information technology. - Kherson: KhNTU, **2013**. - No. 13. - S. 99 - 104.
2. Avrunin O. G. Experience in developing a biomedical system of digital microscopy / O. G. Avrunin // Applied Radioelectronics. - **2009**. - T.8. - No. 1. - S. 46-52.

# THE OVERVIEW OF METHOD OF BALANCED RESOURCE RESERVATION AND MULTICAST ROUTING IN TELECOMMUNICATION NETWORK

**Amal MERSNI<sup>1</sup>, Olena NEVZOROVA<sup>2,\*</sup>, Yelyzaveta TOLSTYKH<sup>3</sup>**

<sup>1,2</sup> Infocommunication engineering Department, Infocommunication Faculty,  
Kharkiv National University of Radio Electronic, Kharkiv, Ukraine

<sup>3</sup> Department of Media Engineering and information radioelectronic systems, Faculty of information radio technologies and technical information security, Kharkiv National University of Radio Electronic, Kharkiv, Ukraine  
amal.mersni@nure.ua<sup>1</sup>, olena.nevzorova@nure.ua<sup>2</sup>, yelyzaveta.tolstykh@nure.ua<sup>3</sup>

## ABSTRACT

The overview of a mathematical model for multicast routing supporting shared explicit reservation of link resource was presented, which is introduced by linear expressions that responsible for ensuring the connectivity of the calculated multicast routes, as well as the absence of loops in them. The novelty of the model consists in introducing conditions for preventing congestion of communication links when implementing a shared explicit reservation, in which a link resource is allocated to several flows simultaneously, but the list of these flows is strictly defined. The task of routing multicast flows supporting shared explicit reservation of link resource is formulated as an optimization problem of mixed integer linear programming. The use of the proposed model makes it possible to exploit the available link resource more efficiently (on average, from 15 to 25%) by ensuring the consistency of solutions for multicast routing tasks and organizing of the shared explicit reservation.

**Keywords:** Multicast routing, resource reservation, network, flow-based model

## **Investigation of the Xenon and Barium Isotopes**

**RAMESH KUMAR**

**Department of Physics Guru Kashi University, Talwandi Sabo, Bathinda, 151001,  
Punjab (India)**

Corresponding Author's Email: [rkgupta1701@gmail.com](mailto:rkgupta1701@gmail.com)

### **ABSTRACT :**

It was found that in conventional IBM, no permanent triaxial deformation is possible in any of the three limits:  $U(5)$ ,  $SU(3)$  and  $O(6)$ . But in the  $O(6)$  limit, the energy functional is independent of  $\gamma$ . Such a system is gamma unstable and will execute large oscillations in gamma. The average value of the variable may not be zero. In this sense the  $O(6)$  limit of IBM is related to the occurrence of triaxiality. Besides, the  $O(6)$  nuclei belong to the transitional region and triaxiality is known to occur in this region. In 1956, Wilets and Jean [1] proposed a geometrical model of gamma unstable nuclei. Meyer-Ter-Vehn [2] showed that the  $O(6)$  limit of the IBM corresponds to the gamma unstable model of Wilets and Jean in the limit of infinite boson number. The two models yield identical  $BE(2)$  values for boson number  $N \rightarrow \infty$ . Thus, the nuclei belonging to the  $O(6)$  dynamical symmetry of IBM is of special importance in the study of triaxiality.

### **References:**

1. Wilets, L. And Jean, M(1956), Phys. Rev. 102,788
2. Meyer-Ter-Vehn (1979), Phys. Lett, 84B, 10
3. Casten, R.F. and van Brentano, P. (1985), Phys. Lett. B152,22

## Detection of “Wall Thinning” Type Defects in Pipelines by Thermal Method

Roman Orel, Sergey Meshkov, Volodymyr Storozhenko, Aleksandr Myagkiy

Department of Physics, Kharkov National University of Radio Electronics  
Ave Nauki, 14, Kharkov, 61166  
Ukraine

Email of corresponding author: roman.orel@nure.ua

Pipeline equipment of various types is widely used in oil and gas, and energy enterprises. After a certain period of operation, due to corrosion from exposure to the environment, cavitation erosion, cracking of welding defects and deterioration of the material, defects arise in the pipes. According to statistics, the cause of more than 50% of explosions, industrial accidents and disasters is undetected pipeline defects.

The thickness of the pipes affects the thermal resistance of the material, which leads to temperature fluctuations on its surface. Using the thermal control method allows to visualize temperature fields and thus to determine the presence of these inhomogeneities in objects.

The capabilities of the thermal method for detecting defects were assessed by a computer experiment, during which a thermophysical model of the object was compiled and the corresponding direct heat conduction problem was solved.

Experimental studies were carried out on pipelines of the second circuit of the Zaporizhzhya NPP. The results obtained during the survey confirmed the data of thermophysical calculations according to the developed model. An important feature identified as a result of inspections of pipelines at low coolant temperatures is the significant influence of external factors. These factors include external lighting, the presence of extraneous heat emitters, heat transfer with the floor of the room [1]. It has been shown that the qualitative differences between these factors and the features of their manifestation make it possible to eliminate their influence.

As a result of the inspection, a “wall thinning” type defect was found, which amounted to about 30% of its nominal thickness. The cause of this defect is cavitation erosion. This was confirmed by ultrasonic testing. The detection of a “thermal trace” during cavitation is an important result. Studies have shown the promise of using the thermal method to determine the state of metals in pipelines.

### References

- [1] S. N. Meshkov, R. P. Orel, *Visnyk Natsional'noho tekhnichnoho universytetu «KHPI». Seriya: Elektroenerhetyka ta peretvoryval'na tekhnika*. **2018**, 8, 154–157.

## Supramoleculartheranostic Platforms Goes Green

Ruken Esra DEMIRDOGEN<sup>1\*</sup>, Derya KILIC<sup>2</sup>, Fatih Mehmet EMEN<sup>2</sup>, Ali İhsan KARACOLAK<sup>2</sup>,  
Muhammad Asım Ali<sup>3</sup>, Emine KUTLU<sup>2</sup>, Tuncay YESILKAYNAK<sup>4</sup>, Göktürk AVŞAR<sup>5</sup>

<sup>1</sup>Faculty of Science, Department of Chemistry, CankiriKaratekin University, Cankiri, TURKEY

<sup>2</sup>Faculty of Arts and Science, Department of Chemistry, Burdur Mehmet AkifErsoy University, Burdur,  
TURKEY

<sup>3</sup> National Institute for Biotechnology and Genetic Engineering, Faisalabad, Pakistan

<sup>4</sup>Department of Chemistry Technology, Afsin Vocational School, Sütcü Imam University, TR46500,  
Kahramanmaras, Turkey

<sup>5</sup>Faculty of Arts and Science, Department of Chemistry, Mersin University, Mersin, TURKEY

Email of corresponding author: rukenesrademirdogen@yahoo.com

World Health Organization projected the number of deaths due to cancer alone to be ~13.1 million by 2030. To a certain extent conventional chemotherapy has been successful, but poor bioavailability, high-dose requirements, adverse side effects, low therapeutic indices, development of multiple drug resistance, and non-specific targeting have been severe limitations to its success[1].

These limitations can be overcome via “theranostics” as it is precision medicine providing simultaneous diagnosis, targeted treatment and monitoring. Here the major actor is the drug –the therapeutic compound. Conventional applications suffer from limited effectiveness, poor biodistribution, and lack of selectivity, but developing new drug molecule is expensive and time consuming. Therefore, for to improve the safety efficacy ratio of “old” drugs by individualizing drug therapy, dose titration, and therapeutic drug monitoring nanotechnology and green chemistry provided the required formulations, which have optimal pharmacokinetic properties for in vivo applications, since their nanosize allowed them to be subject to tissue extravasations and renal clearance whereas their counterparts are quickly opsonized and removed from the bloodstream via the macrophages. Therefore, it is of great need and importance to develop new green chemistries and technologies to produce supramolecular nanomedicines by employing appropriate inorganic and organic structures as theranostic platforms [2].

In this study, M<sub>4</sub>O<sub>4</sub>: Eu-MCM-41-Fe<sub>2</sub>O<sub>3</sub> composite were synthesized. The composite was characterized via FT-IR and XRD techniques and their thermal properties were determined via DTA-TG. Drug releasing studies were carried out in PBS buffer solution.

### References

[1] <https://www.who.int/>

[2]Thakor, A. S., Gambhir, S. S. *CA*,**2013**,63(6), 395-418.

## Synthesis of *Corchoruscapsularis* Fibers Modified with Layered Double Hydroxides and Their Use in Cleaning Waters from Oils

Ruken Esra DEMIRDOGEN<sup>1\*</sup>, Derya KILIC<sup>2</sup>, Aslıhan CESUR TURGUT<sup>3</sup>, Fatih Mehmet EMEN<sup>2</sup>, Tuncay YESILKAYNAK<sup>4</sup>, Ali İhsan KARACOLAK<sup>2</sup>, Muhammad Asım Ali<sup>5</sup>, Emine KUTLU<sup>2</sup>, Göktürk AVŞAR<sup>6</sup>

<sup>1</sup>Faculty of Science, Department of Chemistry, CankiriKaratekin University, Cankiri, TURKEY

<sup>2</sup>Faculty of Arts and Science, Department of Chemistry, Burdur Mehmet Akif Ersoy University, Burdur, TURKEY

<sup>3</sup>Science, Technology and Application and Research Center, Burdur Mehmet Akif Ersoy University, Burdur, TURKEY

<sup>4</sup>Department of Chemistry Technology, Afsin Vocational School, Sütcü Imam University, TR46500, Kahramanmaraş, Turkey

<sup>5</sup> National Institute for Biotechnology and Genetic Engineering, Faisalabad, PAKISTAN

<sup>6</sup>Faculty of Arts and Science, Department of Chemistry, Mersin University, Mersin, TURKEY

Email of corresponding author: rukenesrademirdogen@yahoo.com

In the modern world oils have found more usage areas as fuels and lubricants in the pharmaceutical, petro-chemical and textile industries, in the energy sector and in production of plastics, pesticides and electricity. Each year millions of tons of oils mix into waters. Only in the US every year 3.9 million tons of oil cause water pollution. As result of this both the economy and the ecosystem are severely damaged. Protection of water resources, cleaning them from pollutants and improving them has great economic and ecological importance [1,2]. Layered Double Hydroxides (LDH) -represented with the general formula  $[MII_{1-x}MIII_x(OH)_2] X^+ (Ln^-)_{x/n} mH_2O$ - offers high adsorption efficiency and easy recovery properties. Here  $M^{+2}$  ( $Mg^{2+}$ ,  $Ca^{2+}$ ,  $Ni^{2+}$ ,  $Fe^{2+}$ ,  $Zn^{2+}$ ,  $Cd^{2+}$ ,  $Cu^{2+}$ , ...) and  $M^{+3}$  ( $Al^{3+}$ ,  $Fe^{3+}$ ,  $Cr^{3+}$ , ...) cations fill the octahedral gaps between the buricite like  $-(Mg(OH)_2)-$  layers and the anion  $L^{n-}$  is situated in the hydratized interlayer galleries. LDH's appear as promising structures in phytoremediation for removal of pollutants.

In this study, *Corchoruscapsularis* fibers, which have hydrophilic properties, appropriate pore fiber structure and cellulose and lignin content, will be used. New LDH's with the formula  $[M^{2+}_{1-x}M^{3+}_x(OH)] CO_3^{2-x/2}$ :  $M^{2+}$ :  $Mg^{2+}$ ;  $M^{3+}$ :  $V^{3+}$ ] were synthesized via controlled precipitation method. Then LDH-plant fiber composites taken from the reactor were modified with sodium laurel sulfate (SLS) to give hydrophobic plant fiber-LDH-SLS composite materials. The composite materials thus prepared were characterized via FT-IR, XRD, SEM-EDS techniques. Thus prepared and characterized composites were used as sorbent in removal of oil from waters.

\*This study was supported by TÜBİTAK under the Project number of 118Z008.

### References

- [1] Chen, C., Gunawan, P., Xu, R. *J. Mater. Chem.* **2011**, 21(4), 1218-1225.
- [2] Etkin, D. *S.Environment Canada*; **1999-2000**. 1, 161-174.



## The Study of Classics Particles' Energy at Archimedean Solids with Clifford Algebra

Şadiye ÇAKMAK<sup>1</sup>,

Abidin Kılıç<sup>2</sup>

<sup>1</sup> Eskisehir Osmangazi University, Eskisehir, Turkey.

<sup>2</sup> Eskisehir Technical University, Eskisehir, Turkey.

### Abstract

Geometric algebras known as a generalization of Grassmann algebras complex numbers and quaternions are presented by Clifford (1878). Geometric algebra describing the geometric symmetries of both physical space and spacetime is a strong language for physics. Groups generated from 'Clifford numbers' are firstly defined by Lipschitz (1886). They are used for defining rotations in a Euclidean space. In this work, Clifford algebra are identified. Energy of classic particals with Clifford algebra are defined. This calculations are applied to some Archimedean solids. Also, the vertices of Archimedean solids presented in the Cartesian coordinates are calculated.

**Keywords:** Clifford Algebra, Energy of Archimedean solids's, Archimedean solids.

# Effect of Deformation, Particle-Hole And Particle-Particle Interaction on Gamow-Teller Transitions Of $^{76}\text{Ge}$

Sadiye Cakmak, Cevad Selam<sup>1</sup>

Program of Medical Monitoring Techniques, Osmangazi University  
sadiyecakmak@hotmail.com  
Eskisehir Turkey

<sup>1</sup> Numerical Methods, Faculty of Management Mus Alparslan University,  
c.selam@alparslan.edu.tr  
Mus Turkey

Email of corresponding author: sadiyecakmak@hotmail.com

Gamow-Teller (GT) transitions for  $^{76}\text{Ge}$  using QRPA methods in this article are calculated, which play an essential role in the supernovae. Three different QRPA models are used to the GT strength distributions. QRPA models namely single quasi-particle (sqp), Pyatov Method (PM) [1] and the Schematic Model (SM). Gamow-Teller distribution,  $\Sigma B(\text{GT})$ , the centroid of energy, the width of energy and ISR are calculated by using these models. The effect of particle-particle interaction on spherical nuclei and deformed nuclei on Gamow-Teller transitions is wanted to show. Deformed Woods-Saxon potential is used in calculations of single-particle energies and wave functions. The results are also compared with previous theoretical calculations and measured strength distributions wherever available. It is expected that the current study of GT features would be helpful and may guide to a better knowledge of the presupernova progression of massive stars.

## References

[1] N. I. Pyatov, D. Salamov D, Nucleonica, **1977**, 22, 127.

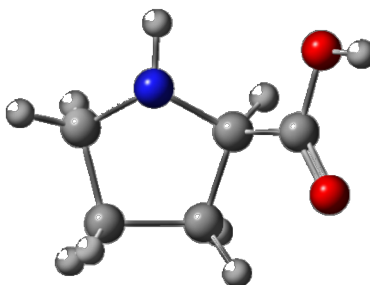
# Structural Analysis and Photophysical Properties of Proline

Saliha Ilıcan\* and Nihal Kus

Department of Physics, Science Faculty, Eskisehir Technical University, Eskisehir, Turkey

\*silican@eskisehir.edu.tr

Amino acids are organic molecules of great biological importance. Although there are more than seven hundred amino acids in nature, only 20-22 of them are basic amino acids encoded by DNA and forming proteins. The difference in the number, variety and sequence of amino acids results in the different types of proteins in each living being [1-3]. Therefore, it is very important to know their structures. Among these Proline (*Pro*; IUPAC: Pyrrolidine-2-carboxylic acid;  $C_5H_9NO_2$ ) is a proteinogenic (protein creating) amino acid that is used in the biosynthesis of proteins. The molecular structure of *Pro* is given in Fig.



**Figure.** The most stable conformer of Proline (*Pro*)

In this work, *Pro* was studied theoretically at the DFT/B3LYP/6-311++G(d,p) level and four conformers with minimum energy were found. The calculations were done for the most stable form (in Fig.). Electronic energies, Gibbs energies, the highest occupied molecular orbital (HOMO) and lowest unoccupied molecular orbital (LUMO) energy values were calculated. The natural bond orbital (NBO) interactions were analysed, and plotted. Electron density surfaces of NBOs for the most stable conformer of *Pro* calculated at the B3LYP/6-311++G(d,p) level of theory showing the dominant orbital interactions.

**Acknowledgement:** This work was supported by Eskisehir Technical University Commission of Research Project under Grant no. 19ADP143.

## References

- [1] I. Wagner, H. Musso, *Angew. Chem. Int. Ed. Engl.* **1983**, 22 (11), 816–828.
- [2] M.C. Michalski, C. Januel, *Trends Food Sci. Technol.* **2006**, 17, 423–437.
- [3] M. M. E.-Dalatony, S. Saha, S. P. Govindwar, R. A.I. A.-Shanab, B.-Hun Jeon, *Trends Biotechnol.* **2019**, in press.

# Fabrication and $I$ - $V$ Characteristics of $p$ - $Si/n$ - $ZnO:Er$ Heterojunctions

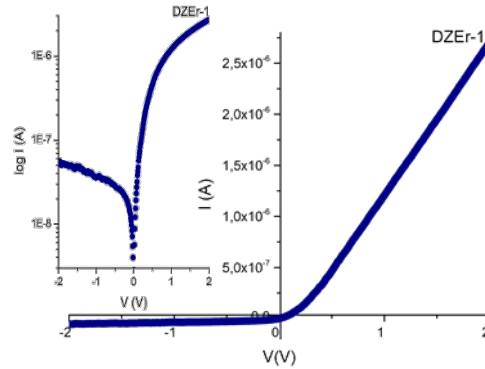
Gonca Ilgu Buyuk<sup>1</sup> Saliha Ilican<sup>2\*</sup>,

<sup>1</sup>Department of Physics, Graduate School of Sciences, Eskisehir Technical University, Eskisehir, Turkey

<sup>2</sup>Department of Physics, Science Faculty, Eskisehir Technical University, Eskisehir, Turkey

\*silican@eskisehir.edu.tr

In recent years, zinc oxide (ZnO) films doped with Rare Earth (RE) elements have been taken attention due to their superior optical and electrical properties. RE elements doping for obtaining wide-bandgap materials gets attention for usage in display applications involving ultraviolet (UV), visible, and infrared (IR) light emission [1-3]. In this work, Erbium (Er) doped ZnO (ZnO:Er) films were deposited onto  $p$ -type silicon ( $p$ - $Si$ ) substrate by sol gel method using spin coating technique. In order to obtained  $p$ - $Si/n$ - $ZnO:Er$  heterojunction structures, top (aluminum; Al) and bottom (gold; Au) metal contacts were deposited using a evaporator and sputter, respectively. The electrical characterization of these heterojunctions were investigated by current–voltage ( $I$ - $V$ ) characteristics at room temperature and in dark. It was observed that  $Au/p$ - $Si/n$ - $ZnO:Er/Al$  heterojunction structures have rectifying properties (Fig.). The electrical parameters such as barrier height, series resistance and ideality factor were investigated by using  $I$ - $V$  measurements. These parameters were determined by using different methods.



**Figure.**  $I$ - $V$  and  $\log I$ - $V$  (insert) characteristics of  $p$ - $Si/n$ - $ZnO:1\%Er$  (DZEr-1) heterojunction diode

**Acknowledgement:** This work was supported by Eskisehir Technical University Commission of Research Projects under Grant no. 1501F032.

## References

- [1] D. Daksh, Y. K. Agrawal, *Rev. Nanosci. Nanotech.* **2016**, 5, 1-27.
- [2] S. Ilican, G. Ilgu, *J. Nanoelectron. Optoelectron.* **2016**, 11, 401-406.
- [3] G. Ilgu Buyuk, S. Ilican, *Black Sea J. Sci.* **2018**, 8(2), 141-153.

# MECHANICAL ACTIVATION OF FLY ASH: PHYSICAL, MINERALOGICAL AND MORPHOLOGICAL CHARACTERIZATION OF GROUND FLY ASHES

Sedef DİKMEN<sup>1,\*</sup>, Zafer DİKMEN<sup>1</sup>, Gülgün YILMAZ<sup>2</sup> Seyhan FIRAT<sup>3</sup>

<sup>1</sup> Dep. of Physics, Science Faculty, Eskişehir Technical University, Eskişehir, Turkey

<sup>2</sup> Dep. of Construction Division, Program in Building Inspection, Eskişehir Technical University, Eskişehir, Turkey

<sup>3</sup> Dep. of Civil Engineering, Technology Faculty, Gazi University, Ankara, Turkey

## ABSTRACT

In this study, physical, mineralogical and morphological characteristics of mechanically treated fly ashes are investigated. The compositional analysis of the raw fly ash was determined using X-ray fluorescence (XRF) technique. The XRD patterns reveal that the main phase quartz along with mullite and anhydrite. The raw fly ash was also wet ground using a laboratory mill, for several different times (from 2 to 16 hours) in order to examine how the grinding increases the activity of the fly ash. The ground fly ash was characterized for (i) particle size distribution: laser diffraction method, (ii) specific surface area: BET-method, (iii) crystalline structure: X-ray diffractometer, and (iv) morphology of particles: scanning electron microscope. According to physical characterization, fineness increasing of samples with grinding time was observed, but loss of effectiveness occurred for grinding time longer than 12 hours. In addition, the unmilled fly ash showed lower specific surface area, due to the presence of cenospheres in the original fly ash. Only a little change in crystalline structure of fly ashes was observed when grinding and there were changes in the area and height of each diffraction peak.

**Keywords:** Ground Fly Ash, Particle Size Distribution, Specific Surface Area, Microstructure, XRD

## ІНФОРМАЦІЯ РЕЗУЛЬТАТУ ВИМІРЮВАННЯ ФІЗИЧНОЇ ВЕЛИЧИНИ

© Ігор Руженцев, Сергій Луцький, 2019

*Харківський національний університет радіоелектроніки (Харків, Україна), завідувач кафедри метрології та технічної експертизи, докт. техн. наук.*

*Харківський національний університет радіоелектроніки (Харків, Україна), старший викладач кафедри метрології та технічної експертизи, канд. техн. наук.*

Одним із напрямків роботи нашої кафедри є дослідження ключового поняття інформація і яке воно має відношення до результату вимірювання фізичної величини.

Теорією інформації займалось багато видатних вчених таких як Хартлі, Фішер, Шеннон, Вінер, Ешбі, Брілюен, Колмогоров та інші.

Історично вперше визначенням поняття кількості інформації займалися Хартлі та Фішер в началі минулого століття. В основу підрахунку кількості інформації Хатлі було запропоновано підрахунок кількості можливих потенційних станів системи і долі їх зміни при взаємодії об'єктів.

Сучасна теорія інформації, як наука появилася тоді, коли була запропонована методика вимірювання числового значення кількості інформації. До цього моменту поняття про інформацію було у сфері філософії і визначалось як властивість навколишнього середовища, так як і фізична величина.

В даний час найбільше використання в науці получила теорія інформації К.Шеннона, яка була започаткована в 1948 році. Кількість інформації по Шеннону характеризує долю ймовірного стану системи на основі закону розподілу ймовірності. Використовуючи формулу ентропії Больцмана, Шенноном було запропоновано формулу розрахунку числового значення кількості інформації і одиницю її вимірювання «біт».

Предметом метрології є отримання кількісної інформації про властивості об'єктів із заданою точністю і достовірністю, нормативна база для цього - метрологічні стандарти. Але поняття кількість інформації вимірюваної фізичної величини і її точність, як сьогодні це інтерпретується не розкриває ключового принципу поняття інформації. В понятті кількість інформації, перш за все мається на увазі міра синхронної і діахронної взаємодії, тобто міра оцінювання зміни можливого стану взаємодіючих об'єктів за рахунок передачі інформації, або міра оцінювання комунікаційної спроможності цих об'єктів.

В рамках проведеної роботи нами було запропоновано методологію розрахунку кількісної інформації комунікаційної спроможності фізичних величин і одиницю її вимірювання «дискретно-ймовірний біт» на основі теорії системно-інформаційного підходу до процесів і систем. В 2017 році у видавництві LAMBERT Academic Publishing вийшла монографія "Discrete-Probable Information of Techno sphere Processes and Systems".

У формулі розрахунку кількості інформації результату вимірювання фізичної величини використовується принцип Хартлі, який базується на законі розподілу невизначеності процесів і систем:  $I(x) = p(x) \log \frac{x}{u(x)}$ , де:  $I(x)$ - кількість інформації,  $x$  -

фізична величина,  $p(x)$  - довірча ймовірність,  $u(x)$  - невизначеність типу В.

1. Руженцев И.В. Системно-інформаційний підхід до метрологічного забезпечення машинобудівних виробництв/ И.В.Руженцев, С.В.Луцький, В.П.Фетькив, О.І.Подзигун // Стандартизація сертифікація якості, Науково-технічний журнал Вип.№1, 2017. — С. 50-55.

2. Руженцев И.В. Мера информации в экономических задачах. / И.В.Руженцев, С.В.Луцький// Сучасний стан наукових досліджень та технологій в промисловості. Науков.журнал ХНУРЕ. №1(1)2017. — С. 110-116.

# Green Reduction of Graphene Oxide by Using Kombucha Tea

Sevil Çetinkaya<sup>1\*</sup>, Nurşah Kütük<sup>1</sup>, Filiz Boran<sup>2</sup>

<sup>1</sup>Sivas Cumhuriyet University, Department of Chemical Engineering, 58140, Sivas/Turkey

<sup>2</sup>Hitit University, Department of Chemical Engineering, Çorum/Turkey

cetinkaya.sevil@gmail.com

Graphene is one of the most important materials in the universe because of its excellent electrical, mechanical and thermal properties. Graphene and its derivatives have attracted the attention of researchers in recent years because of their use in many fields including biological and biomedical [1]. Conventional methods for reducing graphene oxide are toxic to the ecosystem. The toxicity of the chemical agents used in the reduction process such as hydrazine, sodium borohydride is a disadvantage in the use of the material in bio-applications. The green reduction is proposed to be a convenient and safe alternative candidate to conventional methods since it is cost effective and less toxic way for reducing of graphene oxide [2]. Various green reagents such as grape seed, tamarind and leaf extracts have been used on reduction of GO [1,2,3].

In this study, the graphene oxides (GO) was produced from natural graphite powders (NG) based on Hummers' method. Kombucha Tea (KT) was used as natural reductants to reduction of GO. Polyphenol content of KT was determined by using Folin-Ciocalteu method. KT and GO were mixed in various ratios to reduce graphene oxide (RGO) at temperatures of 25, 50 and 85°C. It was clearly observed that the functional groups containing oxygen were reduced as a result of the analyzes. RGOs were characterized by X-Ray Diffraction (XRD), Scanning Electron Microscopy (SEM) and Fourier Transform Infrared (FTIR).

**Acknowledgments:** This study was supported by Sivas Cumhuriyet University Scientific Research Projects (CÜBAP), project number as M702.

## References

- [1] S. Yaragalla, R. Rajendran, J. Jose, MA. AlMaadeed, N. Kalarikkal, S. Thomas, *Materials Science and Engineering*, **2016**, C 65, 345–353.
- [2] S. Thakur, N. Karak, *CARBON*. **2012**, 50, 5331 –5339
- [3] A. Gopalakrishnan, P.Sahatiya, S. Badhulika, *Materials Letters*, **2017**, 198, 46-49

# Effect of the Synthesis Temperature of Polycarboxylate-based Superplasticizers on the Performance of Concrete

Sevil Çetinkaya\*, Melih Özduran, Zeynep Haste Özserçe

Sivas Cumhuriyet University, Department of Chemical Engineering, 58140, Sivas, Turkey

[cetinkaya.sevil@gmail.com](mailto:cetinkaya.sevil@gmail.com)

Today, the most commonly used building material in the construction industry is concrete [1]. The concrete is used with concrete additives in order to reduce the difficulties of preparing, moving, placing and preserving in different conditions to minimum level and turning the problems into advantages [2]. Polycarboxylates (PCEs) are known as a new generation of concrete admixtures [3]. Good quality polycarboxylate (PCE) production is increasingly important due to development of the construction industry in the world. In this study, modified PCE was synthesized by radicalic polymerization method. The effects of PCEs synthesized at different temperatures on the concrete such as water cutting, consistency protection, workability, 7 and 28 days' compressive strength have been examined.

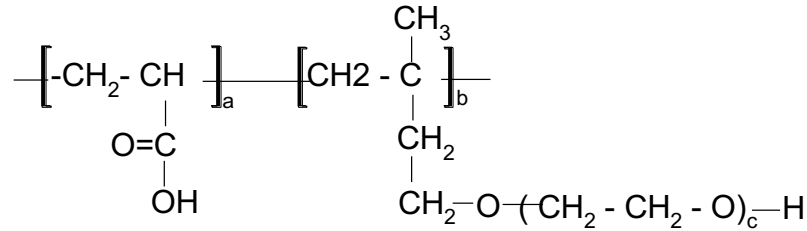


Figure. Molecular structure of PCE

**Acknowledgments:** This study was supported by Sivas Cumhuriyet University Scientific Research Projects (CÜBAP), project number as M744.

## References

- [1] J. Plank, K. Pöllmann, N. Zouaoui, P.R. Andres and C. Schaefer, *Cement Concrete Res.* **2008**, 38, 1210.
- [2] E. Sakai, K. Yamada and A. Ohta, *J. Concrete Technol.* **2003**, 1, 16.
- [3] R.G. Zhang, Q. Li, A.F. Zhang, Y. Liu and J.H. Lei, *J. Wuhan Univ. Technol.-Mater. Sci. Ed.* **2008**, 23, 830.



# Процеси Утворення Позитивних Іонів при Взаємодії Електронів з Молекулами Тиміну

Шафраньош М.І., Суховія М.І., Петруляк В.І., Шафраньош І.І.\*

Фізичний Факультет, Ужгородський Національний Університет  
88000, м.Ужгород, вул.Волошина, 54  
Україна  
ivanshafr@gmail.com

Фізичний вплив вторинних електронів, які виникають у значній кількості в результаті дії первинного високоенергетичного випромінювання на речовину [1], ініціює процеси дисоціативного захоплення, збудження та іонізації молекул азотистих основ нуклеїнових кислот (аденін, тимін, гуанін, урацил та цитозин), які, у свою чергу, запускають ланцюг деструктивних змін у генетичних макромолекулах ДНК і РНК. Природний енергетичний стан цих молекул основ забезпечує стабільність зав'язків у комплементарних парах макромолекул, синтез білків і регуляторні процеси на молекулярному і клітинному рівнях, а також функціонування нуклеїнових кислот як генетичних носіїв. Зміни (мутації), які виникають внаслідок опромінення молекули ДНК, а також їх наслідки є процесом непередбачуваним і результати такої взаємодії проявляються лише через деякий час (наступні покоління).

Раніше [2] було експериментально досліджено процеси утворення негативних і позитивних іонів молекул тиміну електронним ударом. У даній роботі приведені результати моделювання процесів утворення позитивних молекулярних іонів тиміну за допомогою квантово-хімічних програм.

Моделювання процесів утворення позитивно заряджених фрагментів, які представлені в мас-спектрі тиміну було представлено за допомогою квантово-механічного методу AM1. Цей метод входить в пакет програм HyperChem 8.0.7. Розрахунках були виконані використовуючи метод AM1 в режимі оптимізації всіх структурних параметрів з нормою градієнта  $< 0,01$ . Для фрагментації молекулярного іону необхідним є одночасний розрив принаймні двох зв'язків в кільцевій структурі молекулярного іона тиміну. Основна ідея запропонованої моделі утворення зарядженого фрагменту полягає у тому, що розрив зв'язків найбільш ймовірно відбувається у тих місцях, де сума довжин зв'язків є найбільшою. Виявлено шість найбільш ймовірних розривів зв'язків в циклічній структурі молекулярного іона тиміну. Отримані результати добре узгоджуються з даними експериментальних досліджень. Показано, що модельний опис фрагментації біомолекули дає можливість розділити утворення двох позитивно заряджених фрагментів, які мають однакове відношення  $m/z$ .

## Література

[1] V. Cobut, Y. Frongillo, J.P. Patau et al., *Radiat. Phys. Chem*, **1998**, 51, 229-243.

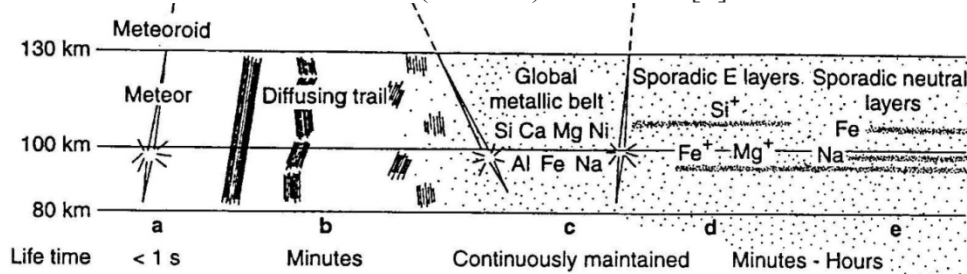
[2] И.И. Шафраньош, М.И. Суховия, М.И. Шафраньош, Л.Л. Шимон, *ЖТФ*, **2008**, 78(12), 7-11.

## Meteoroids: chemistry, radio engineering and celestial mechanics

Kolomiyets S.V.\*, Kyrychenko I.Yu.

Radio Astronomy Research Laboratory named B.L. Kashcheyev, Kharkiv National University of Radio Electronics,  
14 Nauky ave., Kharkiv 61166,  
Ukraine  
Email: [svitlana.kolomiyets@nure.ua](mailto:svitlana.kolomiyets@nure.ua)

If we talk about a very distant astronomical event with name - kilonova, as the possible source of substances such as gold and platinum (metals in the Earth's crust), then it is interesting to track the orbital history of the scattered kilonova fragments, along with its physical and chemical history. Laboratory studies along with modeling, etc. play an important role in clarifying the physico-chemical processes in the Universe. Note that gold and platinum were also found in meteorites (cosmic "stones" that fell to Earth, e.g. [1]). So it is necessary to pay special attention to the research of meteor events. We will talk about meteoroids, i.e. objects associated with the intrusion of cosmic bodies into the Earth's atmosphere. We list some important topics of the research of meteors (including interdisciplinary topics) based on the requests of an observer located on the surface of the Earth: a) conduct special laboratory experiments to study the meteor object itself; b) track the orbital combination of meteor objects with meteorites, interplanetary or interstellar objects; c) observe the spectra of meteor objects; d) observe the products of combustion; e) evaluate the factors of space weather, etc. Humanity has the ability to use natural laboratories to track the dynamics and properties of cosmic substances not as distant from the Earth as the kilonova. Such closest natural laboratories are: the surrounding space, the atmosphere of the Earth, etc. Thus, meteor objects are good probes for studying many interesting processes in the Universe. The accumulation of statistics for the entire meteor data set continues to be relevant. An important point in new research is taking into account experience of previous years. Based on a sample of analyzed scientific literature of the second half of the XX century, e.g. [2], a review of radar, lidar and others methods for the study of meteoroids was given. (see meteor events in **Figure** [3]). The article presents new special statistical data for meteors and meteoroid orbits based on the results of radar observations in Kharkiv (Ukraine) and others [4].



**Figure:** Credit [3]. Development in time of meteor events in the Earth's atmosphere

### References

- [1] A.V. Telnova, *Proceedings of the 17th International Scientific Symposium 'Problems of Geology and Subsurface Development', Tomsk, 2013*, 1, 634
- [2] W.G Ayers, R.E. McCrosky, C.-Y. Shao, *Special Report 1970*, 317, 1
- [3] A. Pellinen-Wannberg et. al. *Ann. Geophysical.*, **1998**, 161,1475-1485.
- [4] S.V. Kolomiyets, *Proceedings of the IAU S325 (Astroinformatics)*, **2016**, 12,389

# Use of Wavelet Techniques in the Study of Internet Marketing Metrics

Murad Omarov, Tetiana Tikha 1, Vyacheslav Lyashenko\*

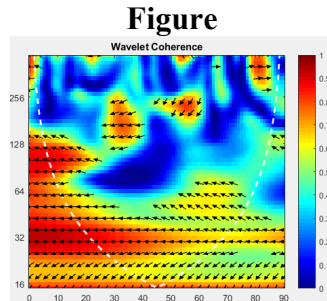
Department of Natural Sciences,  
Kharkiv National University of RadioElectronics,  
Kharkiv, Ukraine  
Email of corresponding author: tetiana.tykha@nure.ua

Internet marketing is becoming widespread in all areas of activity both for individual users of virtual space and for businesses [1]. At the same time, modern Internet technologies allow to track the number of conversions (site visits) made from each advertisement. You can also collect relevant statistics for which keywords your site finds on search engines and the like. Such data is essential for evaluating the effectiveness of management decisions from the perspective of all stakeholders using Internet marketing. Therefore, it is equally important to disclose such data in terms of visualizing the existing links between individual metrics for the implementation of Internet marketing. To solve this problem, we use wavelet technology, in particular, wavelet coherence [2]. It is a cross-link analysis tool in the data series under study. For this purpose the following equation is applied:

$$R^2(q, q_1) = \frac{|\Pi(q_1^{-1}\Omega_{xy}(q, q_1))|}{\Pi(f_1^{-1}|\Omega_x(q, q_1)|^2)\Pi(q_1^{-1}|\Omega_y(q, q_1)|^2)},$$

де:  $\Pi$  is a smoothing operator,  $\Omega_{xy}(f, f_1)$  is a cross wavelet spectra for different time series  $q$  and  $q_1$ ,  $x$  is a time variable,  $y$  is a frequency component cross wavelet spectra in time  $t$  for rows  $q$  and  $q_1$ .

The figure shows the value of the coherence wavelet between the data that determines thmultiple requests for shoes "shoes" and "sandals" within 90 days, starting on 05/06/2019.



Analyzing the data shown in the figure, you can determine the intersections of requests for "shoes" and "sandals", and therefore to build a strategy for conducting the appropriate direction of Internet marketing..

## References

- [1] M. Omarov, T. Tikhaya, V. Lyashenko, *Int. J. Civil. Eng. Tech.* **2018**, 9, 1233-1240.
- [2] V. Lyashenko, Z. Deineko, A. Ahmad, *Int. J. Science. Eng. Res.* **2015**, 6, 1492-1499.

# Conversion Marketing Model for Advanced Optimization Tasks

Tetiana Tykha

Department of Natural Sciences,  
Kharkiv National University of RadioElectronics,  
Kharkiv, Ukraine  
Email of corresponding author: tetiana.tykha@nure.ua

Internet marketing is one of the components of modern information technologies that uses the methods of classical marketing to conduct marketing activities on the Internet in accordance with the conceptual bases of the functioning of information systems [1, 2]. However, expanding the boundaries of using traditional tools to improve existing means of introducing modern Internet marketing requires the isolation and disclosure of possible combinations of classic and modern Internet marketing technologies. Such combinations include conversion marketing, which is related to the motivation of potential customers [1]. A key goal of conversion marketing is to reverse the negative attitude of consumers to products and restore demand.

In formalized form, conversion marketing can be defined as the solution of an optimization problem, where we have a set of potential customers  $\{P_i\}$  and which should be transformed into a set of customers  $\{K_j\}$  under certain conditions ( $i = \overline{1, O}$ ). Among these conditions are the following: goods database –  $\{T_k^n\}$ , which consists of a separate set of subspecies  $k$  ( $n = \overline{1, B}$ ). There are also a number of factors that can turn potential customers into customers. Therefore, we have a number of tools that work on the Internet  $\{IM_m\}$ , which affect the price of the item of a particular variety –  $V_k$ . Then the essence of the condition is the transformation of many potential consumers  $\{P_i\}$  for many customers  $\{K_j\}$  can be viewed in accordance with the maximization of the total profit gained from the sale of available goods from the goods base  $\{T_k^n\}$ :

$$\{K_j\} \cdot \{T_k^n\} \cdot V_k \rightarrow \max_{\{K_j\} \in \{P_i\}}, \quad (1)$$

where a number of conditions are fulfilled, for example: the presence of positive mutual influence of individual potential buyers and clients on each other, which is determined by some parameter  $Q$ :

$$\{K_j\} \cdot \{T_k^n\} \cdot V_k - \{K_{O-j}\} \cdot \{T_k^n\} \cdot V_k^{B-n} \rightarrow Q_{\{K_j\} \in \{P_i\}}. \quad (2)$$

## References

- [1] M. Omarov, T. Tikhaya, V. Lyashenko, *Int. J. Civil. Eng. Tech.* **2018**, 9, 1233-1240.
- [2] R. Kaur, G. Singh, *Int. J. Scient. Res. Comp. Science. Eng. Inf. Tech.* **2017**, 2, 253-258.

## **Determination of sialic acid level in blood serum of rats as marker of anti-inflammatory action of pharmaceutical composition containing piroxicam and caffeine**

**Syrova G.O., Tishakova T.S., Savelieva O.V.**

Inflammatory diseases are one of the most common human pathologies. It is to be noted that nowadays young people, leading an active lifestyle, seek medical advice just as often as elder people. Young active people consult a doctor because pain and deformation in joints means incapacitation for them and results in decreasing of life quality.

Modern medicine has a wide range of anti-inflammatory medicinal products but persistent long-term use safety concerns must be considered when prescribing these medications for chronic and degenerative pain conditions. That's why search of new pharmaceutical compositions that suppress inflammation and have a low risk of adverse reactions is important today.

One of the promising trends in this search is a development of new pharmaceutical compositions on the base of non-steroidal anti-inflammatory drugs (NAID) with caffeine. Piroxicam is characterized by high efficiency and safety compared to other NAIDs and caffeine is known as adjuvant of NAIDs. Besides, pharmaceutical composition of piroxicam with caffeine is absent on the pharmaceutical market of Ukraine.

For that reason aim of this research was investigation of anti-inflammatory action of pharmaceutical composition containing piroxicam and caffeine compared to mono-preparation and reference drug – sodium diclofenac.

Anti-inflammatory action of studied preparations was analyzed using biochemical parameter – sialic acid (SA) level.

Biochemical investigations on the piroxicam, caffeine and their pharmaceutical composition by the side of reference drug sodium diclofenac were performed on rats of WAG line with the average weight 200 - 230 g. Animals were divided on 6 groups (6 rats per group).

Rats of 1 group were injected once perorally intragastrically with 3% starch mucus (2 ml per 200 g body weight). In 2 group formalin edema was simulated with sub-planetary injection of 2% formalin solution to the rat's posterior paw and animals were injected intragastrically with 3% starch mucus. Rats of 3 group were injected piroxicam (1.3 mg per 1 kg body weight); 4 group - caffeine (0.6 mg per 1 kg body weight) ; 5 group - composition of meloxicam with caffeine (1.3 mg/0.6 mg per 1 kg body weight); 6 group - (the reference one) - diclofenac sodium (8 mg per 1 kg body weight).

Content of SA was determined by Hess method.

Experimental study of anti-inflammatory effect showed that SA level in the blood of intact animals was  $1.305 \pm 0.014$  mmol/L, under the conditions of formalin-induced paw edema SI level increased –  $2.862 \pm 0.021$  mmol/L. It was shown that mono-administration of piroxicam under the formalin-induced paw edema resulted in downward trend of SA level ( $2.325 \pm 0.023$  mmol/L). Mono-administration of caffeine decreased SA level 1.7 times compared to formalin-induced paw edema ( $1.543 \pm 0.024$  mmol/L). Pharmaceutical composition containing piroxicam and caffeine was more effective – it decreased SA level 2 times in comparison with formalin-induced paw edema model. Investigated composition acted at a level of reference drug ( $1.421 \pm 0.004$  mmol/L).

It was found that piroxicam and caffeine in composition effect the level of SI and have anti-inflammatory activity against the formalin edema compared to reference drug – sodium diclofenac.

# **Brinell Indentation Diameter Measurement without Using An Optical Microscope**

Utku Kaya

Program in Railroad Electric and Electronics Tech, Vocational School Of Transportation  
Eskisehir, Turkey

utkukaya@eskisehir.edu.tr

The Brinell hardness test method has been in common use for over 100 years. Brinell test method provides hardness measurement near deformed or cracked zone. In this work, there is an approach to obtaining several railway steel samples' hardness by using spherical indenter without optical measurement. Spherical indentation diameter is commonly effected by sink-in and pile-up effect that influences optical measurement negatively. Because of that, the purposed approach aims to obtain average hardness values by using indentation and relaxation curves.

**Keywords:** Brinell hardness, Indentation diameter, Spherical indenter, Sink-in, Pile-up

# **Construction the information systems of knowledge based on service-oriented architecture using neural networks**

Murad Omarov, Vusala Muradova 1

Department of Natural Sciences,  
Kharkiv National University of Radio Electronics,  
Kharkiv, Ukraine

Email of corresponding author: viusalia.muradova@nure.ua

The subject of research is the design and development of information systems and management processes of knowledge formation. Objective: to analyze the modern information technologies and service-oriented systems used to organize and control the processes of formation of knowledge as well as practical and methodological approaches used in these technologies. The following tasks are solved in the article: development of information technology, organization and management of the processes of knowledge formation on the basis of methods and models of service-oriented systems. This technology is based on the functional requirements of the processes of knowledge formation. The following results were obtained: The relevance of the scientific objectives was analyzed. The results of the analysis of the modern models, methods and information technologies in processes of knowledge formation confirmed the need for the development of information technology processes control the formation of knowledge, which will improve the effectiveness of decisions. It was identified that this technology needs to be developed based on service oriented architecture [1].

Information technology (IT) is intensively used throughout the world in various fields. It is almost impossible to do without using them. In modern conditions the actual problem of implementation of information technologies in education. An integral part of this process is the creation of new and improvement of existing systems, the process of knowledge formation.

Distance learning is one of the areas in knowledge creation. It has its own specifics and, in some situations, is the most effective form of process of knowledge. Managing the process of knowledge creation can be implemented on the basis of information technology.

Service oriented architecture (SOA) is a new direction in building a corporate automated information systems and is specifically designed for integration multi-platform applications supporting business processes in manufacturing [2,3]. Service - oriented architecture arose from the need to create reliable it services across the enterprise can be centrally coordinated.

Conclusions: the Developed information technology management processes of knowledge formation based on service-oriented architecture with the use of new methods and models of processes of formation of knowledge.

## **References**

- [1] М.Омаров, В. Мурадова., J. Scientific Notes of the Azerb. Technic. Univer. **2016**, 3, 204-214.
- [2] Биберштейн Н., Боуз С. Компас в мире сервис-ориентированной архитектуры (SOA). М.: Кудиц Пресс, **2007**. 228 с.
- [3] Шаппелл Д.А. ESB – Сервисная Шина Предприятия. – СПб.: БХВ Петербург, **2008**. 347 с.



## Adsorption Capacity on Toxic Metals Ions of the Silica Gel Surface, *In Situ* Modified by poly[8-methacroyloxy quinoline]

Polonska Y.<sup>1</sup>, Yanovska E.<sup>1</sup>, Savchenko I.<sup>1\*</sup>, Ol'khovik L.<sup>1</sup> Sternik D.<sup>2</sup>,  
O. Kychkyruk<sup>3</sup>, Kokhan P.<sup>1</sup>

Chemistry Department, Taras Shevchenko National University of Kyiv,  
60, Volodymyrska str., 01601 Kyiv, Ukraine

<sup>2</sup>Solid Surface Department, Maria Curie-Skłodowska University,  
Maria Curie-Skłodowska Sq., 20-031 Lublin, Poland

<sup>3</sup>Natural Sciences Department, Ivan Franko Zhytomyr State University,  
42, Pushkina Str., 10008 Zhytomyr, Ukraine

e-mail: iras@univ.kiev.ua

8-oxyquinoline and its derivatives are widely known ligands that form strong complexes with the ions of most transition metals. Processes of complex formation are characteristic also for oxine-containing polymers. Therefore, the immobilization of oxine-containing polymers on the surface of porous inorganic matrices allows for the emergence of new composite materials that can be used as effective complex-forming sorbents for metal cations due to their complexation with nitrogen atoms of the oxyquinoline of the immobilized polymer.

One of the promising ways of creating such organo-mineral composite materials with interesting and valuable sorption properties is the *in situ* immobilization of a polymer on the surface of a porous inorganic carrier, which consists in the direct formation of an immobilized polymeric layer in the presence of particles of an inorganic carrier. The advantage of this method of immobilizing polymers on solid surfaces is its versatility with respect to the chemical nature of the carrier. It can be successfully applied to carriers of different shapes and rigidity and is the only way to obtain a polymer layer on porous and powder nanoscale carriers.

This work is devoted to the *in situ* modification of the silicagel surface by poly [8-methacryloxy quinoline] and to the study of the sorption properties of the synthesized material with regarding ions of Pb (II), Cd (II), Cu (II), Mn (II), Zn (II) and Fe (III).

Heterophase polymerization of 8-hydroxyquinolyl methacrylate was carried out in tetrahydrofuran in the presence of azobisisobutyric acid dinitrile as initiator at 62 ° C for 5 hours. The fact of polymer immobilization on the surface of silica gel was confirmed by IR spectroscopy and thermogravimetric analysis combined with mass spectrometry. Methods for scanning electron microscopy and adsorption-desorption of nitrogen were used to study the morphology of the silica gel surface after immobilization of the polymer.

Comparison of the sorption properties of the initial and modified with silica gel polymer has shown that as a result of the modification of the silicagel surface by poly [8-methacryloxy quinoline], the sorption properties of the ions of Lead (II), Manganese (II), Copper (II) and Iron (III) are improved. In particular, there is a quantitative removal of the microhardness of these toxic ions, and the sorption capacity increases from 0.002 to 0.072 mmol/g for Pb (II) ions, from 0.006 to 0.065 mmol/g for Cu (II) ions, from 0.01 to 0.024 mmol/g for ions Mn (II) and from 0.008 to 0.254 mmol/g for Fe (III) ions.

## Информационно-коммуникационные технологии в информатизации экономики Республики Азербайджан

Юсиф Гасимов<sup>1</sup>, Асиф Пашаев<sup>2</sup>, Бахрам Азизов<sup>3</sup>

<sup>1</sup>Проректор по науке, Университет Азербайджан, Баку, Азербайджан.  
*Yusif.gasimov@au.edu.az*

<sup>2</sup>Декан факультета ИКТ, Университет Азербайджан, Баку, Азербайджан.  
*Asif.pashayev@au.edu.az*

<sup>3</sup>Доцент кафедры Математика и Информатика, Университет Азербайджан, Баку, Азербайджан. *Bahram.azizov@au.edu.az*

В связи с новым доминированием научно-информационной составляющей в экономике, активным распространением ИКТ, формированием глобальных и сетевых информационных потоков структура экономики Азербайджана постоянно изменяется.

Актуальность темы заключается в изучении рынка информации Республики Азербайджан с наблюдаемыми инфраструктурными изменениями в направлении информатизации общества, развития рынка ИКТ, совершенствованием стратегии развития инновационных технологий и управления предприятий.

*Ключевые слова: Информация, система, ИКТ, экономика, информатизация общества, электронное правительство, рынок информации.*

### ЛИТЕРАТУРА:

- [1] Тузовский, И. Д. Утопия-XXI: глобальный проект «Информационное общество». Челябинск: Челяб. гос. акад. культуры и искусств, 2014. 392 с.
- [2] Буряк В. В. Глобальное гражданское общество и сетевые революции. Симферополь: ДИАЙПИ, 2011. 152 с.
- [3] Погорский Э. К. Становление информационного общества в РФ: диалог между гражданами и органами местного самоуправления. Научные труды Московского гуманитарного университета. 2011.
- [4] Корнейчук Б. В. Информационная экономика. Учебное пособие. СПб. Питер, 2006. 400с.
- [5] Письмак В.П., Ратушин Ю.А., Поленок С.П. Создание отраслевых региональных информационно-аналитических систем в сети информационно-маркетинговых центров стран СНГ. Финансовые риски, №2(43), 2006.
- [6] <https://ict.az>

## NEW TRENDS FOR TYPE II SUPERLATTICES

M. Hostut<sup>1</sup>, A. Kılıç<sup>2</sup>, Y. Ergun<sup>2</sup>,

<sup>1</sup>Akdeniz University, Education Faculty, Antalya

<sup>2</sup>Eskisehir Technical University, Dept of Physics, Eskisehir

### ABSTRACT

In the literature, there are high performance infrared superlattice photodetector structures as nBn and pBp detectors, M-structured detectors, W-structured detectors, Complementary barrier infrared detectors (CBIRD), PbIbN-structured detectors and N-structured detectors whose patent process continue and are taken place in the literature by us as a new design. This structure based on a type-II super lattice pin diode is designed for investigating the e-hh wave function overlap functions under reverse bias.

W structures are designed for electron confinements in InAs quantum wells by GaSb barriers on the basis of placement 2-3 mono layers (MLs) GaInSb in the InAs wells where electron confinements take place at the GaSb/InAs interfaces while M-structures are designed for containing AlSb barrier in the GaSb as an electron or hole barrier by placement of ternary GaAlSb barriers for pushing the photo carriers into the same GaSb/InAs interfaces. On the other hand structures such as CBIRD and nBn are designed to suppress diffusion current by placing hole and electron barriers in p and n side of the structure respectively. Our design of N-structure aimed to improve hole confinement at the InAs->GaSb transition interface where absorption is decisively revealed in the intrinsic region under reverse bias. The structure is called N-structure on the base of real space band profile of GaSb/AlSb/InAs superlattice system. The device is aimed to increase electron hole overlap by about 25% leading to increase quantum efficiency and to suppress the G-R component of dark current effected at low temperatures while increasing the detectivity. ee-hh overlaps calculations were carried out under potential energy~0,002 eV per period in the i-absorption region of n-I-p structure and the results have published. Other study on this structure have presented orally in QSIP-2012 conference Cargase/France. This study is being published online in the Journal of Infrared Physics and Technology. Beside this, the results have presented by orally in 2012-IMRS Cancun/Mexico conference and the results will be published in Physica E in a comparison to studies given in the literature. The work carried out by First Principle Calculations is accepted as oral presentation for 12th International Workshop on Advanced Infrared Technology and Applications (AITA2013) held in 10-13 September 2013 in Torino/Italy (<http://ronchi.isti.cnr.it/AITA2013/program.html>). As long as band gap energies of the system has been calculated according to layer thickness correctly, pseudo-potentials calculations with plane wave approach have to be done since Bloch functions of the system may not be calculated correctly. Especially in 3-5  $\mu\text{m}$  atmospheric window monolayers are more, then, First Principle Calculations take a lot of time and also the absorption and scattering (electron - phonon) processes leads to calculations may not being correctly. For this reason, band calculations are necessary by using Empirical Pseudopotential Method (EPM).

In this work, InAs/AlSb/GaSb type-II superlattice based new detector structure working in the 3-5  $\mu\text{m}$  atmospheric windows will be explained. Non-local terms related bulk band structure, band gap and effective mass values will be done in the most accurate way in different temperatures by using Empirical Pseudopotential Method - EPM. Crystal structure will be growth after the investigations of structural parameters such as layer thicknesses are obtained by the theory. High resolution x-ray diffraction method are used to define lattice periodicity and strain to determine crystal quality and temperature dependent current-voltage ( $I-V$ ) characteristics are carried out in this study.

## **Smart Grid Integrated With Hybrid Renewable Energy Systems**

Zafer Demir<sup>1</sup>, Omer Aydın<sup>2</sup>

<sup>1</sup>Eskisehir Technical University, Porsuk Vocational School, zaferdemir@eskisehir.edu.tr

Eskisehir, Turkey

<sup>2</sup>Eskisehir Technical University, Graduate Education Institute, omeraydin@eskisehir.edu.tr

Eskisehir, Turkey

The growing world population and fossil fuel reserves have been aimed at alternative searches as energy sources due to a decreasing curve. The rate of formation of Fossil fuels does not exhibit a parallel formation of the amount of consumption according to the years. Nowadays, no matter how many alternative suggestions are revealed, there is no way to choose them yet. Despite the use of fossil fuels such as coal, oil and natural gas in energy production, the rapid depletion of these resources has increased the direction of us to renewable energy sources. The key advantage of renewable energy sources is the ability to create a hybrid system with other energy sources. Hybrid systems allow the combined use of different energy sources and the integration of renewable energy sources into the existing system. This study provides examples of hybrid renewable energy systems and information on how to integrate into existing systems. One of the most important applications to increase the use of renewable energy resources is the systems that are used together with different energy sources and are called hybrids. Today, it has become mandatory to analyze various working conditions as well as in large power systems of renewable energy-induced hybrid systems that are widely used.

## Comparison of fly ash and red mud mixtures on physical and morphological characteristics

Zafer Dikmen\*, Sedef Dikmen

Department of Physics, Eskisehir Technical University, Eskisehir, Turkey

zdikmen@anadolu.edu.tr

This study is concerned with recycling waste materials, focusing on the development of building materials from coal fly ash and red mud. The purpose of this research was to determine the usability of producing building materials with the mixture two different fly ash and red mud. Fly ash and red mud were mixed by different weight ratio, and the mixture was wet milled in a planetary ball mill. After milling, the mixture was pressed into a cylindrical form having a diameter of 15 mm and length of 30 mm without using any binder. The cylindrical samples were sintered at different temperatures between 850-1150 °C with rate of firing 6 °C/min. The crystallization behavior and morphological properties were carried out with the help of X-ray diffraction (XRD), field emission-scanning electron microscopy (FE-SEM), and energy dispersive X-ray spectrometer (EDX). In addition, various physical properties, such as bulk density, compressive strength and water absorption were determined at each sintering temperature. As a result samples with red mud made by mixing two different fly ash samples were compared with each other.

**Keywords:** Building material, Fly ash, Red mud, SEM, compressive strength.

# NUMERICAL ERROR ANALYSIS FOR CONFIGURABLE CELL SEGMENTATION PROBLEM

Nataliya BILOUS <sup>1\*</sup>, Oleg HRAMM <sup>1</sup>, Iryna AHEKIAN <sup>1</sup>, Abed Thamer KHUDHAIR <sup>2</sup>,

Ludmila ILLYASHENKO <sup>3</sup>, Alexander NERUKH <sup>4</sup>

<sup>1</sup> Department of Software Engineering, Faculty of Computer Sciences, Kharkiv National University of Radio Electronics, Kharkiv, Ukraine

<sup>2</sup> Department of Informatics, Kuliyyah Al-Maarif University College, Anbar, Iraq

<sup>3</sup> Outsourcing Scientific Training Pproduction Center, Kharkiv National University of Radio Electronics, Kharkiv, Ukraine

<sup>4</sup> Department of Higher Mathematics, Faculty of Information and Analytical Technologies and Managment, Kharkiv, Ukraine

## ABSTRACT

The current intense interest in gold nanoparticles is due to their Surface Plasmon Resonances (SPR) that depend strongly on the shape and size of the nanoparticles. As the SPR wavelength and resonantly enhanced absorption and scattering properties also depend on the dielectric medium in which gold nanoparticles are embedded, and also depend on the way of their clustering, they are useful to design novel nanodevices, in particular when it is based on ideas taken from nature. With purpose to select the most promising configurations for novel nanodevice design in this work the method of cell recognition and evaluation of its efficiency is proposed. Exist different methods to produce microscopic images, they can be obtained for different types of cells in different environments. Due to this fact, the recognition algorithms are needed. All methods have their advantages and disadvantages and may work well only under certain conditions. Therefore, it is useful for each specific task to implement a separate algorithm that will be effective for the existing set of images, and take into account the peculiarities of these images. The task of this work is not only to develop flexible and customizable algorithm, that can be configured to segment cells on different types of images, but also provide numerical error analysis corresponding to each step of algorithm. As a result, a solution is developed, that has many customizable parameters to optimize the result for a specific data set and specific accuracy. In addition, this it is resistant to a lot of noise and artifacts, that can occur on images, such as uneven background, small debris, loss of focus when shooting. Numerical error analysis allows getting form of cell segmentation more precisely to be reproduced for novel nanostructured device design.

Keywords: Cells recognition, Segmentation, Watershed; Hough transform, Plasmonic nanoparticles, Error estimation

## **The relationship between headache types and blood groups and socioeconomics factors**

Jabbar Al Lemane

Sciences and Technology University, Lebanon

In this study, the relationship between headache and blood groups and socioeconomic status was investigated. In the study conducted on 127 subjects, it was found that there was an important correlation between them. In addition, educational status and family conditions of the subjects were taken into consideration.

## **Application of Machine Learning Systems to Bioinformatic Resources**

Len Si Hian

Ocean University of China

Many data centers, clouds and grids consist of a large number of computer systems, each with a different structure. In this study, the appropriateness of various learning techniques in the use of resources depending on space and time was evaluated comparatively. Learning techniques that employ a large number of features are used, taking into account application and system-specific features. In certain scenarios where use, system, and application attributes are a nonlinear function, some configurations of other different machine learning algorithms, the Vector Machine, and the nearest neighbors give competitive results. In addition, experiments show that the inclusion of system performance and application-specific features increases the performance of the machine learning algorithms investigated.



# Some Models of Mechanical and Thermal Properties of Skin in the Context of Plastic Surgery

A.E. Kokorev, A.O. Kiriak, O.G. Avrunin\*

Department of Biomedical Engineering, Kharkiv National University of Radio Electronics  
61166, 14 Nauka Ave., Tel. (057) 702-03-69  
Kharkiv  
Ukraine

Email of corresponding author: d\_bme@nure.ua

The simplest model of the structure of the blood circulation of the skin is the angiosomal theory [1]. According to this model, the human body is divided into separate three-dimensional sections, fed by individual branches of the arteries. Further studies showed that angiosomes are not completely isolated, but are reported via anastomoses at the level of skeletal muscle [2]. Despite this, the significance of angiosomal theory remains in the field of plastic surgery [3].

Blood supply to the skin is very heterogeneous in time and space. For different areas of the body, it can differ by more than two times. Moreover, the blood flow is not constant, but is subject to fluctuations with a period that depends on various regulatory influences.

There are three approaches to modeling the mechanical properties of the skin: macro-, meso-, and micromechanical. The first of them is based on the representation of the skin as an abstract elastic material [5, 6]. The second is based on histological information, such as the depth and distribution of the elastic material of the skin [4, 7]. The third takes into account the detailed structure and behavior of collagen and elastin molecules [8].

The basic equation for modeling heat transfer in tissues is the biothermal equation [9].

Mechanical models of the skin are reduced to calculating the relationship of stress-strain. Then it becomes possible to select such deformations so that the stress is minimal. This will allow planning the surgical intervention in such a way as to facilitate the healing process of the stitched wound, since it is known that the edges of the scar undergo stretching [5]. We also believe that the combination of the above models will make it possible to predict skin growth under the influence of external tension when applying the method of tissue expansion.

## References

- [1] G.I. Taylor, J.H. Palmer. *British Journal of Plastic Surgery*. **1987**, 40, 113-141.
- [2] A.A. Ponomareva. *The J. of Fundamental. Med. and Biology*. **2018**, 2, 34-44.
- [3] K.V. Selyaninov. *Iss. of Reconstructive and Plastic Surgery*. **2014**, 3(50), 29-42.
- [4] A.E. Fedorov et al. *Russian Journal of Biomechanics*. **2007**. 11(1), 76–83.
- [5] D.A. Danielson. *J. of Biomechanics*. **1973**, 6(5), 539–546.
- [6] O.G. Avrunin, Y.V. Nosova et al. *Przegląd Elektrotechniczny*. **2017**, 93(3), 140-143.
- [7] O.G. Avrunin et al. *Optical Fibers and Their Applications*. **2015**, 98161L.
- [8] Y. A. Lanir. *Ibid*. **1979**, 12(6), 423–436.
- [9] H.H. Pennes. *J. of Appl. Physiology*. **1948**. 1, 93–102.

# **FLEXIBLE MANUFACTURING TENDENCIES AND IMPROVEMENTS WITH VISUAL SENSING**

**Artem BRONNIKOV<sup>1</sup>, Igor NEVLIUDOV<sup>1</sup>, Oleksandr TSYMBAL<sup>1</sup>**

<sup>1</sup>Computer Integrated Technologies And Mechatronics Department, Faculty of Automatics And Computerized Technologies,  
National University of Radioelectronics, Kharkiv, Ukraine

## **ABSTRACT**

The proposed article contains the review of modern tendencies in flexible manufacturing systems. The applications of intelligent control systems for modern manufacturing are considered. As one of key elements of production control, article deals with tasks of visual monitoring for distributed production workspaces.

**Keywords:** flexible manufacturing, robotics, image processing, adaptive control, image stitching

# Absorption Spectra of Triple Compounds MPbI<sub>3</sub> (M=Cs, Rb, K) Thin Films.

E. N. Kovalenko<sup>a</sup>, O. N. Yunakova<sup>b</sup>, N. N. Yunakov<sup>b</sup>.

<sup>a</sup>Kharkiv National University of Radio Electronics,  
Nauka Ave., 14, 61166,  
Kharkiv,  
Ukraine

<sup>b</sup>V. N. Karazin Kharkiv National University,  
Svobody Sq., 4, 61022,  
Kharkiv,  
Ukraine

The compounds MPbI<sub>3</sub> are isostructural, they crystallize at room temperature into a perovskite-like orthorhombic lattice with 4 molecules in a unit cell. The structural elements of the MPbI<sub>3</sub> lattices are double chains consisting of (PbI<sub>6</sub>)<sup>4-</sup> octahedra oriented along the short *c* axis.

The absorption spectra of MPbI<sub>3</sub> thin films were studied in the spectral range of 2 - 6 eV and the temperature range of 90 - 520 K. The isostructural nature of the compounds determines the similarity of their absorption spectra (Fig. 1). A narrow exciton A<sub>1</sub> band and shorter wavelength C and D bands are observed in the MPbI<sub>3</sub> spectra, the positions of which are given in Table. 1.

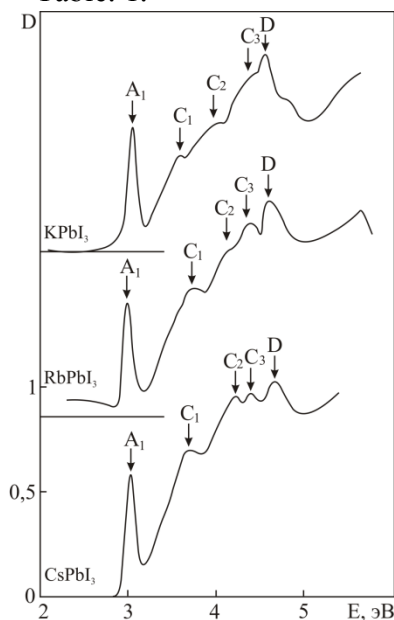


Fig. 1. Absorption spectra of KPbI<sub>3</sub>, RbPbI<sub>3</sub>, CsPbI<sub>3</sub> thin films

Table 1. Spectral position of absorption bands in MPbI<sub>3</sub> (M=K, Rb, Cs).

Compound	E <sub>A1</sub> , eV	E <sub>C1</sub> , eV	E <sub>C2</sub> , eV	E <sub>C3</sub> , eV	E <sub>D</sub> , eV
KPbI <sub>3</sub>	3,027	3,58	3,97	3,36	4,56
RbPbI <sub>3</sub>	2,975	3,73	4,105	4,4	4,63
CsPbI <sub>3</sub>	3,013	3,69	4,22	4,4	4,461

Close spectral position of the long-wavelength exciton bands in MPbI<sub>3</sub> indicates the localization of excitons in the sublattice containing plumbum ions, in the (PbI<sub>6</sub>)<sup>4-</sup> octahedra. Therefore, the spectra of MPbI<sub>3</sub> are interpreted on the basis of electronic transitions in (PbI<sub>6</sub>)<sup>4-</sup> octahedra like spectra of impurity ions Pb<sup>2+</sup> in the alkali-halide crystals. In other words, the A-bands in the MPbI<sub>3</sub> spectra correspond to the transitions  $^1A_{1g} \rightarrow ^3T_{1u}$ , while the C-bands correspond to the transitions  $^1A_{1g} \rightarrow ^1T_{1u}$ .

With increasing temperature, the A<sub>1</sub> band in CsPbI<sub>3</sub> linearly shifts to the low-frequency region of the spectrum with  $dE_m/dT = -2.45 \cdot 10^{-4}$  eV/K, in RbPbI<sub>3</sub> – with  $dE_m/dT = -1,73 \cdot 10^{-4}$  eV/K. In KPbI<sub>3</sub>, the  $E_m(T)$  dependence of the A<sub>1</sub> band, taken by heating the sample, revealed a short-wavelength shift of the band at  $T_{c2} = 205$  K, apparently due to the intercalation of the film by CO<sub>2</sub> molecules, which leads to an increase in the unit cell volume. The temperature behavior of  $\Gamma(T)$  indicates the excitation of 2D excitons in KPbI<sub>3</sub> and 3D in CsPbI<sub>3</sub> and RbPbI<sub>3</sub>.



ICONAT 2019

FULL TEXTS



lifecell

# Photo-Isomerization Reactions of Oxygen Containing Molecules using Matrix Isolation Spectroscopy

Nihal Kuş

Department of Physics, Science Faculty, Eskisehir Technical University,  
Yunus Emre Campus, 26470 Eskisehir, Turkey

## Abstract

In this paper, the matrix isolation infrared spectroscopy technique is briefly presented, and its application to the study of photoisomerization reactions of a set of selected oxygen containing heterocyclic compounds is reviewed. The considered photoreactions include conformational isomerizations as well as bond-breaking/bond-forming structural isomerizations.

Keywords: *Matrix isolation IR spectroscopy/ photoisomerization reactions/ oxygen containing heterocycles*

## 1. The Matrix Isolation Method

The matrix isolation technique is a technique in which atoms and molecules in the gaseous state are trapped in rare gases at very low temperatures. This technique has found research in many laboratories and has been studied spectroscopically.

If a chemical species (the studied sample) is trapped at high subsidization into a frozen inert gas at a temperature close to the absolute zero, then intramolecular reorganizations are stopped for the process which barrier larger than a few kJ mol<sup>-1</sup>. Furthermore, the matrix rigidity keeps diffusion, and, as a consequence, bimolecular reactions are suppressed as well at high matrix-to-sample ratios. Under these conditions, even unstable or short-lived species can be preserved and studied at leisure. *In situ* photolysis and/or matrix annealing enable selective introduction of energy, controlling the range of probable reorganizations of isolated matrix samples by overcoming activation barriers. With this method, many intramolecular changes, decompositions and formation of new molecules can be examined.

The infrared spectra of the isolated molecule in the matrix give a much sharper peak and can be analyzed better. Because the external molecules do not affect the isolated molecules. These experimental results are in agreement with the theoretically calculated spectra. At the same time, the rotational spectra are eliminated.

The father of the matrix isolation method is George Pimentel. George Porter started to work in different places at the same time [1, 2]. The first publication on matrix isolation was published in the Journal of Chemical Physics in 1954 by George Pimentel et al. [1]. This method became popular 20 years later and three publications were published by different groups at the same time, which described the photochemistry of an oxygen containing heterocyclic compound:  $\alpha$ -pyrone (Figure 1) [3-5].

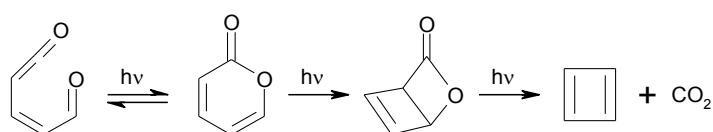


Figure 1 – Observed  $\alpha$ -pyrone photochemical reaction pathways [3-6].

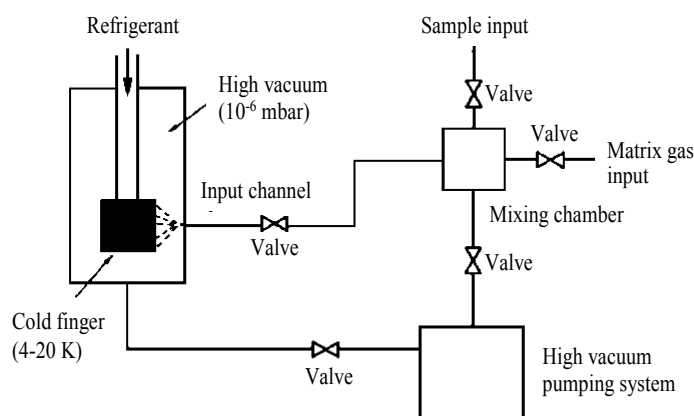
Although the matrix isolation technique is considered a technique for the study of new reactive species, it is more advantageous than other techniques. These advantages:

i) being able to observe new reagent species as a result of examination of the stored sample during deposition,

ii) analyzing isomeric or dissociated molecules during by photolysis,

iii) freezing and analyzing the conformation of molecules.

One of the most important advantages of this method is that the low temperature molecule is more rigid and the environment is not affected by other chemical reactions. As a result of this advantage, molecules do not interact with each other, solute-solvent interactions can be controlled in the appropriate inert gas, molecular diffusion, rotation and hot vibrational transitions are not observed since very pure vibrational spectra are observed (therefore very easily comparable to theoretical spectrum calculations), is not observed. Another advantage in addition to these is that the matrix isolation set does not cost very expensive (Figure 2).



**Figure 2** – Scheme of a matrix-isolation set up [7-9].

There are also some disadvantages of working with matrix isolation IR spectroscopy:

i) the molecule must evaporate without decomposition when stored.

ii) determination of matrix concentrations at very low temperatures is very difficult.

iii) in some cases, spectral analysis spectra of the multiplet structure are observed. This problem can also be minimized by adjusting the temperature.

iv) the method has limited application to study biochemically important problems in view of the required low temperature and considerable volatility and thermal stability of the molecules to be studied.

Many biologically compounds have been studied by matrix isolation IR spectroscopy, for example, DNA bases [10-12], amino acids [13-18] and the other pharmaceutical and medical molecules [19].

In the next section of this paper, a few illustrative examples of application of the matrix isolation IR spectroscopy method for studying selected oxygen containing heterocyclic compounds are presented. The compounds here considered are amongst the simplest and most common oxygen containing heterocyclic molecules. The studies provided as selected examples are mostly our own studies, and include conformational and structural isomerization processes, ring-opening reactions and other rearrangement processes.

## **2. Illustrative examples of application of matrix isolation IR spectroscopy**

As mentioned in the previous section of this article,  $\alpha$ -pyrone and its derivatives exhibit a very reach and interesting photochemistry. One of the most interesting matrix studies was the work that

started with alpha pyron in the 70's. [4,5,20]. In this study, ketene was observed by opening the ring as a result of UV radiation ( $\lambda = 313$  nm) of the matrix. The second product, dewar, appeared very slowly. and UV irradiation resulted in cyclobutadiene with decarboxylation ( $\text{CO}_2$ ) [5,20].

Recently, matrix isolated  $\alpha$ -pyrone studies were reworked [6]. and it was almost the same as the previous results. However, theoretical calculations were done at higher levels. This advantage resulted the photoproduction of the E forms of Z and conjugated ketene was proved spectroscopically first time.

Several substituted  $\alpha$ -pyrones have also been studied, including 4,6-dimethyl- $\alpha$ -pyrone [21], coumarin (2*H*-1-benzopyran-2-one) [22] and 3-acetamido-coumarin [23]. As a result of the study, the formation of Dewar isomers is much more effective than in the case of dimethyl derivative, photo-reaction of alpha cleavage is happening. This leads to the formation of aldehyde ketene. [6,21]. Upon  $\lambda > 200$  nm UV-irradiation 3 main different photoreactions were observed (Figure 3):

(a) decarboxylation of the compound formed benzocyclobutadiene and  $\text{CO}_2$ . The intermediate product was Dewar coumarin.

(b) as a result of the opening of the ring formed ketene; and

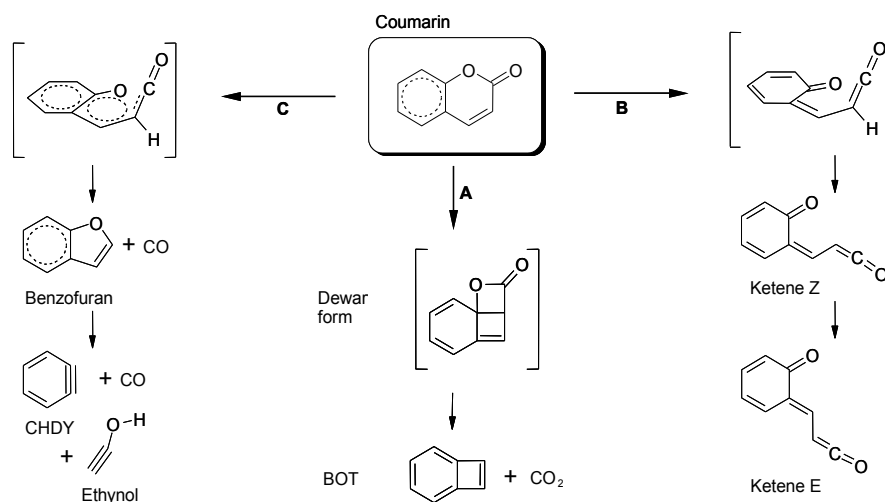
(c) and decarbonylation resulted in CO complex with benzofuran.

Further It was argued that ethynol could be formed by decomposition of benzofuran. [22]. In the other study, 3-acetamido-coumarin [23] dewar photo product was not observed, only the ketene formed by opening the ring and observed for 2-pyrone-3-carboxylate [24]. This result appears to be a fairly general rule for alpha-pyrons.

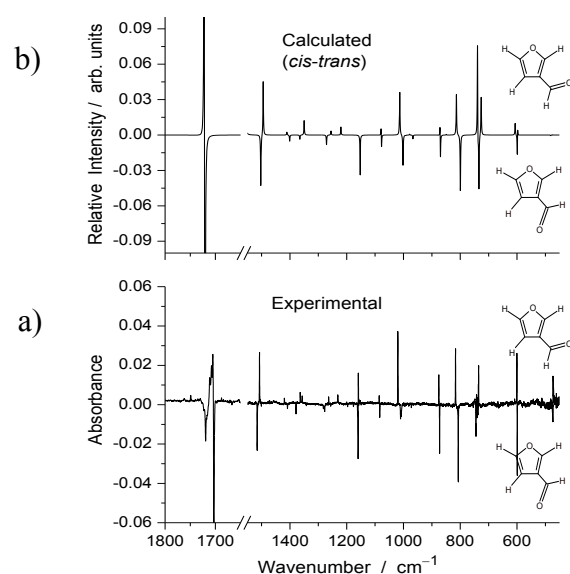
Matrix isolation coupled with IR spectroscopy has been shown to be particularly powerful in the study of conformational isomerization processes. Conformational photoisomerization of 3-furaldehyde (3FA) was found to be especially interesting [25], and will be here mentioned as prototype illustrative example.

3FA has two conformation depending on the aldehyde orientation (Figure 4), energy difference between two forms is about  $4 \text{ kJ mol}^{-1}$ . As a results of UV-irradiation ( $\lambda > 234$  nm) of the compound (Figure 4), the transformation of their conformation was observed. As a result of TD-DFT calculations, excited states and energies were determined.

The obtained population ratio at the photostationary state was explained based on results of time-dependent DFT calculations. [25].

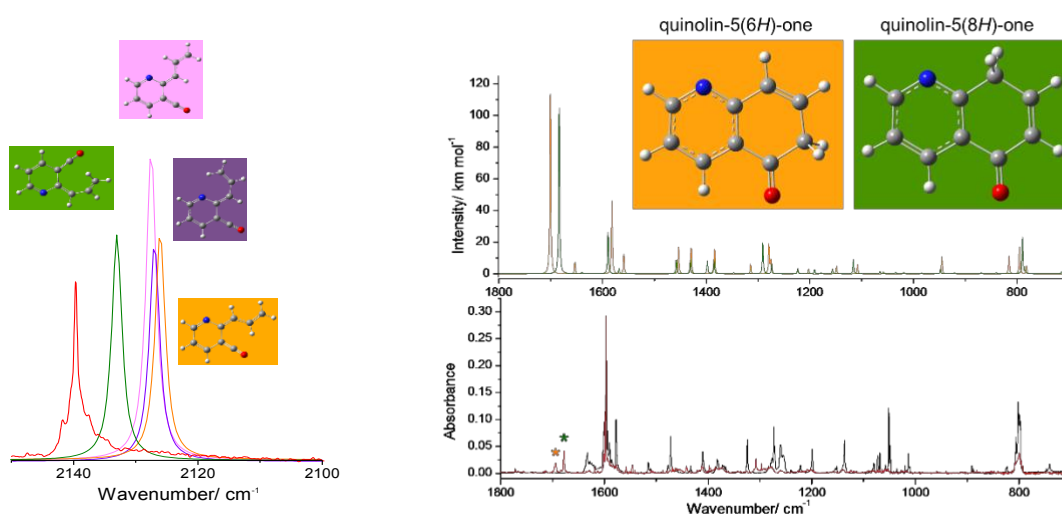


**Figure 3** Photo-products observed as a result of UV radiation. BOT= benzocyclobutadiene; CHDY = cyclohexa-1,3-dien-5-yne (benzyne) [22].



**Figure 4** a) difference infrared spectrum (irradiated *minus* as-deposited matrix) of 3FA, showing the *trans*→*cis* photoisomerization. b): calculated simulated *cis-trans* difference spectrum [25].

Another interesting study was the photochemistry of the 5HQ molecule in a low temperature (10 K) N<sub>2</sub> matrix [26]. The observed photochemistry resembles that previously observed in case of phenol, and probably starts also by photoabstraction of the hydroxylic hydrogen atom, followed by its recombination with the 5-quinolin-phenoxy radical. However, in 5HQ, the presence of the pyridine ring imposes steric restrictions (compared to phenol) which do not allow observation of the Dewar derivative (10-azatricyclo[4.4.0.0<sup>1,4</sup>]deca-2,7,9-trien-5-one). On the other hand, the destabilization of the Dewar isomer, precluding transformation of the quinolin-5(6H)-one in that species, results in the possibility of observing the last compound (Figure 5).

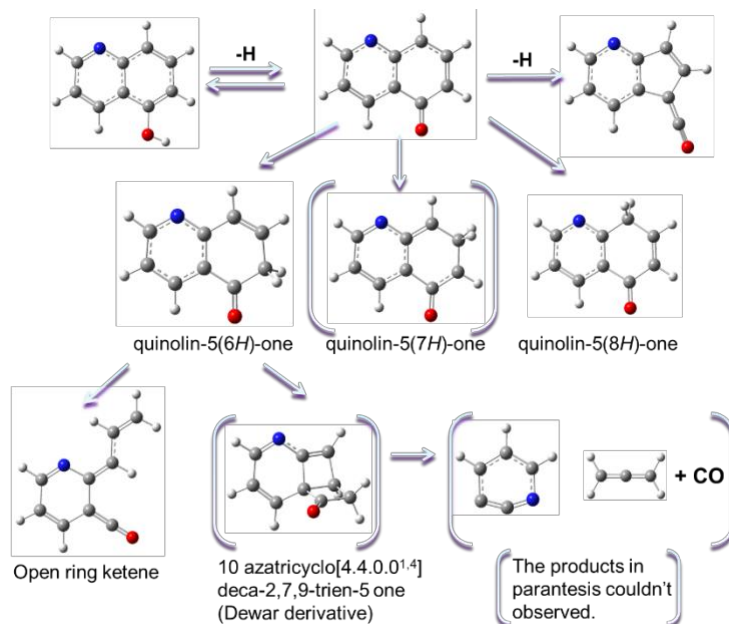


**Figure 5.** Summary of the photochemical reactions calculated and observed for matrix-isolated 5HQ upon irradiation with  $\lambda > 235$  nm (black deposited, red irradiated spectra).

Upon irradiation at  $\lambda \geq 288$  nm the compound isomerizes to both quinolin-5(8H)-one and quinolin-5(6H)-one. Upon prolonged irradiation at the same conditions, as well as when irradiation



was performed at higher energies ( $\lambda \geq 235$  nm), quinolin-5(6H)-one undergoes a ring-opening reaction leading to production of a ketene species, while quinolin-5(8H)-one was found to be rather photostable (Figure 6).



**Figure 6.** UV irradiation results for isolated of 5HQ in a N<sub>2</sub> matrix.

## BIBLIOGRAPHY

- Whittle, E., Dows, D.A., and Pimentel, G.C. 1954, *J. Chem. Phys.*, 22, 1943.
- Norman, I., and Porter, G. 1954, *Nature*, 174, 508.
- Lin, C.Y., and Krantz, A. 1972, *J. Chem. Soc. Chem. Commun.*, 1111/1112, 1316.
- Chapman, O.L., McIntosh, C.L., and Pacansky, J. 1973, *J. Am. Chem. Soc.*, 95, 244.
- Pong, R.G.S., and Shirk, J.S. 1973, *J. Am. Chem. Soc.*, 95, 248.
- Breda, S., Reva, I., Lapinski, L., and Fausto, R. 2004, *Phys. Chem. Chem. Phys.*, 6, 929.
- Rochkind, M.M. 1967, *Anal. Chem.*, 39, 567.
- Perutz, R.N., and Turner, J.J. 1973, *J. Chem. Soc., Faraday Trans. 2*, 69, 452.
- Barnes, A.J., Bignall, J.C., and Purnell, C.J. 1975, *J. Raman Spectrosc.*, 4, 159.
- Lapinski, L., Rostkowska, H., Khvorostov, A., Fausto, R., and Nowak, M.J. 2003, *J. Phys. Chem. A*, 107, 5913.
- Szczesniak, M., Leszczynski, J., and Person, W.B. 1992, *J. Am. Chem. Soc.*, 114, 2731.
- Buyl, F., Smets, J., Maes, G., and Adamowicz, L. 1995, *J. Phys. Chem.*, 99, 1496.
- Stepanian, S.G., Reva, I.D., Radchenko, E.D., Rosado, M.T.S., Duarte, M.L.T.S., Fausto, R., and Adamowicz, L. 1998, *J. Phys. Chem.*, 102, 1041.
- Jarmelo, S., Lapinski, L., Nowak, M.J., Carey, P.R., and Fausto, R. 2005, *J. Phys. Chem. A*, 109, 5689.
- Gómez-Zavaglia, A., Reva, I.D., and Fausto, R. 2003, *Phys. Chem. Chem. Phys.*, 5, 41.
- Gómez-Zavaglia, A., and Fausto, R. 2003, *Vibrat. Spectrosc.*, 33, 105.
- Stepanian, S.G., Reva, I.D., Radchenko, E.D. and Adamowicz, L. 1998, *J. Phys. Chem. A*, 102, 4623.
- Kaczor, A., Reva, I.D., Proniewicz, L.M., and Fausto, R. 2006, *J. Phys. Chem. A*, 110, 2360.
- See, for example, (a) Reva, I.D., Jarmelo, S., Lapinski, L., and Fausto, R., 2004, *Chem. Phys. Lett.*, 389, 68. (b) Ramaekers, R., Maes, G., Adamowicz, L., and Dkhissi, A. 2001, *J. Mol. Struct.*, 560, 205. (c) Borba, A., Gómez-Zavaglia, A., Lapinski, L., and Fausto, R. 2004, *Phys. Chem. Chem. Phys.*, 6, 2101. (d) Sander, W., Wandel, H., Bucher, G., Grafenstein, J., Kraka, E., and Cremer, D. 1998, *J. Am. Chem. Soc.*, 120, 8480.
- Chapman, O.L., McIntosh, C.L., and Pacansky, J. 1973, *J. Am. Chem. Soc.*, 95, 614.
- Breda, S., Lapinski, L., Reva, I., and Fausto, R. 2004, *J. Photochem. Photobiol. A*, 162, 139.
- Kuş, N., Breda, S., Reva, I., Tasal, E., Ogretir, C., and Fausto, R. 2007, *Photochem. Photobiol.*, 83, 1237. Erratum: *ibidem*, 83, 1541.
- Kuş, N., Breda, S., and Fausto, R. 2009, *J. Mol. Struct.*, 924-926, 81.
- Reva, I.D., Nowak, M.J., Lapinski, L., and Fausto, R. 2008, *Chem. Phys. Lett.*, 452, 20.

25. Kuş, N., Reva, I., and Fausto, R. 2010, *J. Phys. Chem. A*, 114, 12427.
26. Kuş, N., Sagdinc S., Fausto, R. 2015, *J. Phys. Chem. A*, 119, 6296.